

Panasonic®

2.4 GHz Multi-Handset Digital Cordless Phone

Operating Instructions

Model No. **KX-TG2357**

Pulse-or-tone dialing capability

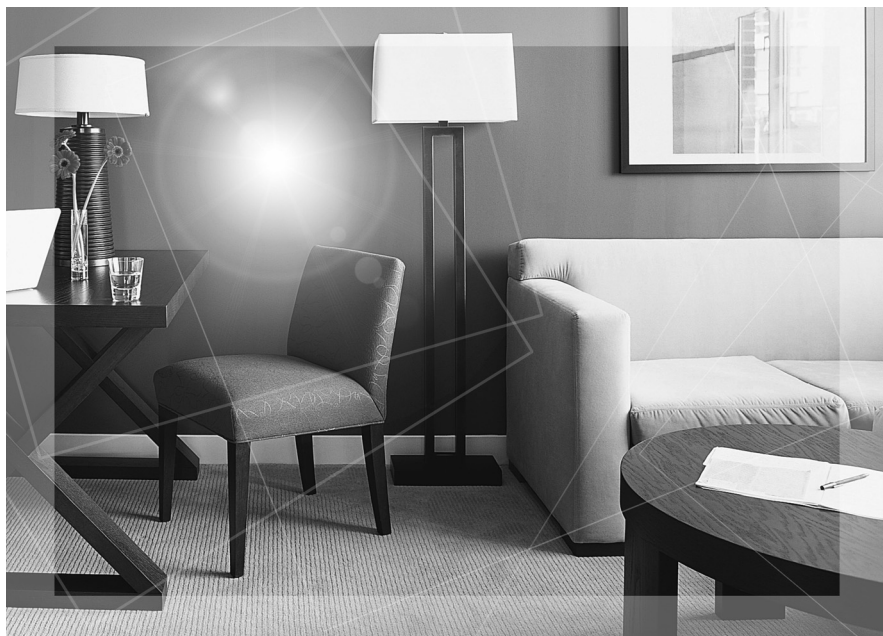

The unit is Caller ID compatible. To display the caller's name and phone number, you must subscribe to Caller ID service.

PLEASE READ BEFORE USE AND SAVE.

Charge the battery for 6 hours before initial use.

Panasonic World Wide Web address: <http://www.panasonic.com>
for customers in the USA or Puerto Rico

Thank you for purchasing your new Panasonic cordless telephone.

Please read the IMPORTANT SAFETY INSTRUCTIONS on page 82 before use. Read and understand all instructions.

Caller ID and Call Waiting Service, where available, are telephone company services. After subscribing to Caller ID this phone will display a caller's name and phone number. Call Waiting Caller ID, which displays a second caller's name and phone number while the user is on another call, requires a subscription to both Caller ID and Call Waiting with Caller ID Services (CWID).

Attach your purchase receipt here.



Trademarks:

openLCR, openLCR.com, and the openLCR logo are the trademarks of openLCR.com, Inc.

Accessories (included)

For extra orders, call 1-800-332-5368.

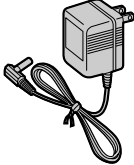
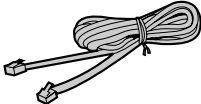
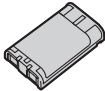
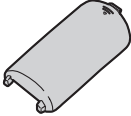
For hearing or speech impaired TTY users, call 1-866-605-1277.

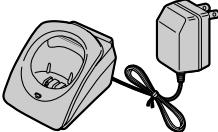
<input type="checkbox"/> AC Adaptor (p. 9) Order No. PQLV1Z (PQLV1)  one	<input type="checkbox"/> Telephone Line Cord (p. 9) Order No. PQJA10075Z  one
<input type="checkbox"/> Battery (p. 10) Order No. HHR-P104  two	<input type="checkbox"/> Handset Cover (p. 10) Order No. PQKK10141Z2 (Black) PQKK10141Z1 (Silver)  two
<input type="checkbox"/> Belt Clip (p. 66) Order No. PQKE10375Z2 (Black) PQKE10375Z3 (Silver)  two	<input type="checkbox"/> Charger Unit (p. 9) Charger Order No. PQLV30023YB (Black) PQLV30023YS (Silver) AC Adaptor Order No. KX-TCA1-G (KX-TCA1)  one

For Best Performance

Battery Charge

The handset is powered by a rechargeable Nickel-Metal Hydride (Ni-MH) battery. Charge the battery for **6 hours** before initial use (p. 10).

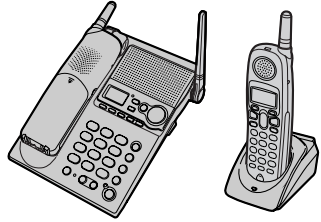

Base Unit Location/Noise

Calls are transmitted between the base unit and handset using wireless radio waves. **For maximum distance and noise-free operation**, the recommended base unit location is:

Away from electrical appliances such as a TV, personal computer or another cordless phone.

In a HIGH and CENTRAL location with no obstructions such as walls.

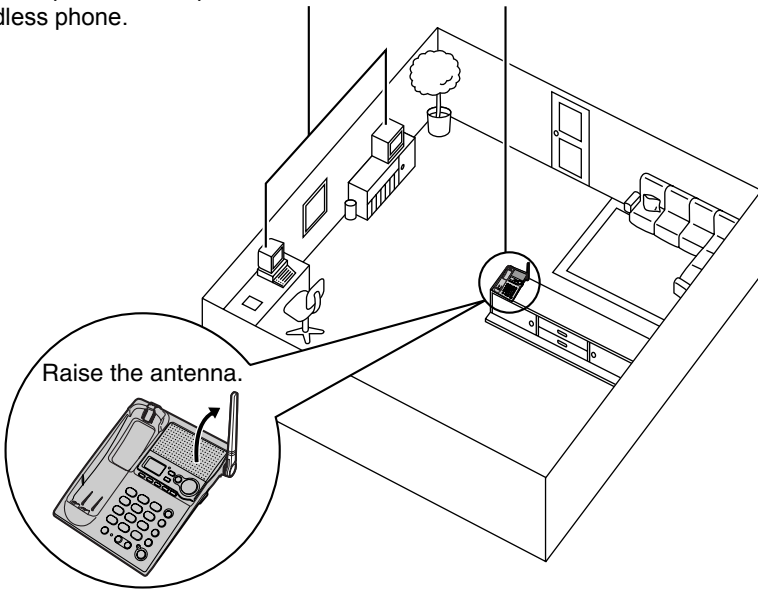

Note:

- If you use the handset near a microwave oven which is being used, noise may be heard from the receiver or the speaker. Move away from the microwave oven and closer to the base unit.
- If you use the handset near another cordless phone's base unit, noise may be heard. Move away from the other cordless phone's base unit and closer to your base unit.

Contents

Preparation

Location of Controls	6
Installation	9
Connections	9
Installing the Battery in the Handset	10
Battery Charge	10
Programmable Settings	12
Programming Guidelines ..	12
Function Menu Table	13
Date and Time	14
Display Language	15
Dialing Mode	15
Line Mode	16
Auto Talk	16
Ringer Volume	17
Ringer Tone	18
LCD Contrast	20

Preparing the Answering

System	20
Greeting Message	20
Caller's Recording Time ..	22
Number of Rings	23
Recording Mode	24
Message Alert	24

Telephone System

Making Calls	25
Using the Handset	25
Using the Base Unit	28
Answering Calls	29
Caller ID Service	30
Talking Caller ID	31
Using the Caller List	32
Viewing the Caller List ...	33
Calling Back from the Caller List	33
Editing the Caller's Phone Number	34

Caller ID Number Auto Edit	35
Storing Caller Information in the Phone Book	36
Erasing Caller Information .	37

Phone Book

38	
Storing Names and Numbers	38
Dialing from the Phone Book	40
Chain Dial	41
Editing an Item in the Phone Book	42
Erasing an Item in the Phone Book	42
Copying Items in the Phone Book	43

Intercom

45	
Making Intercom Calls	45
Answering Intercom Calls .	46
Voice Paging	47

Transferring a Call

48	
Conference Calls	50
Call Share	50

Special Features

51	
Temporary Tone Dialing (For Rotary or Pulse Service Users)	51
Muting Your Conversation .	51
For Call Waiting Service Users	51
Using the PAUSE Key (For PBX Line/Long Distance Calls)	52
FLASH Button	52
Incoming Call Tone	53
Key Tone	54
Re-registering the Handset	54

Answering System

Automatic Answering	
Operation	55
Setting the Unit to Answer	
Calls	55
Monitoring Incoming Calls .	56
Listening to Messages	57
Using the Base Unit	57
Using the Handset (Remote	
Operation)	58
Erasing Messages	60
Recording a Memo	
Message	61
Remote Operation from a Touch	
Tone Phone	62
Remote Code	63
Voice Menu	64
Direct Remote Operation .	65

Useful Information

Belt Clip	66
Optional Headset	66
Wall Mounting	67
Direct Commands	69
If the Following Appear on Your	
Display...	71
Troubleshooting	73
openLCR Service	
for Caller IQ	78
Turning Caller IQ on or off .	78
Downloading Data	79
Important Safety	
Instructions	82
FCC and Other Information .	84
Index	87
Warranty	89
Specifications	91

Important:

Throughout these Operating Instructions, **Handset** and **Base Unit** are used to indicate with which unit an operation can be performed.

Handset : Perform with the handset.

Base Unit : Perform with the base unit.

Handset Base Unit : Perform with the handset and base unit separately.

Handset & Base Unit : Perform with the handset and base unit together.

Location of Controls

Base unit

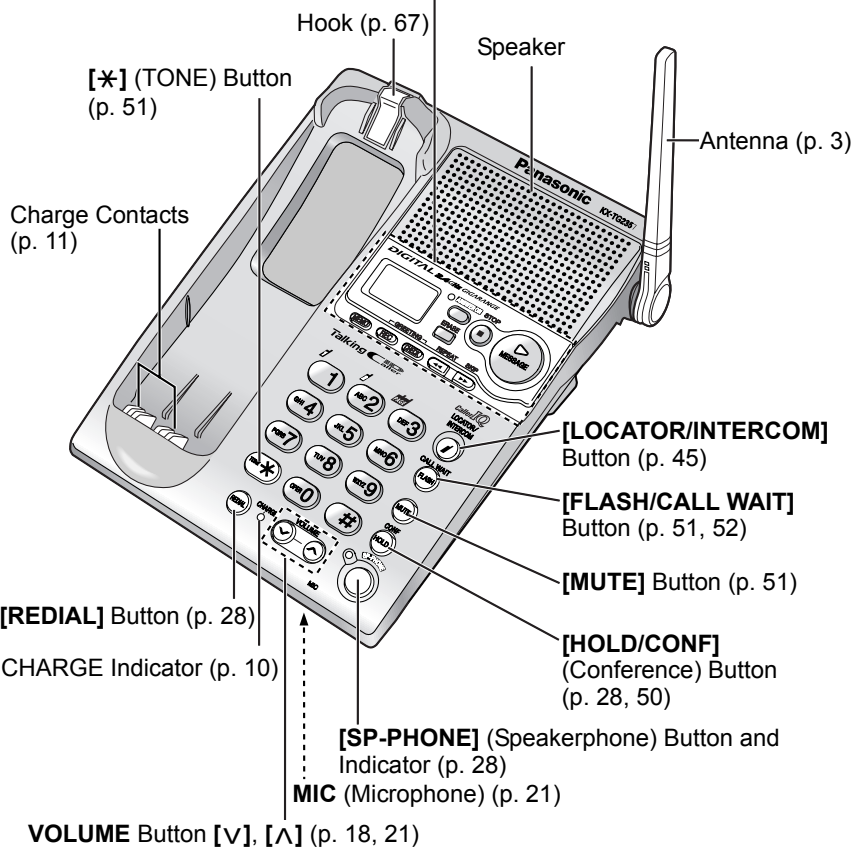
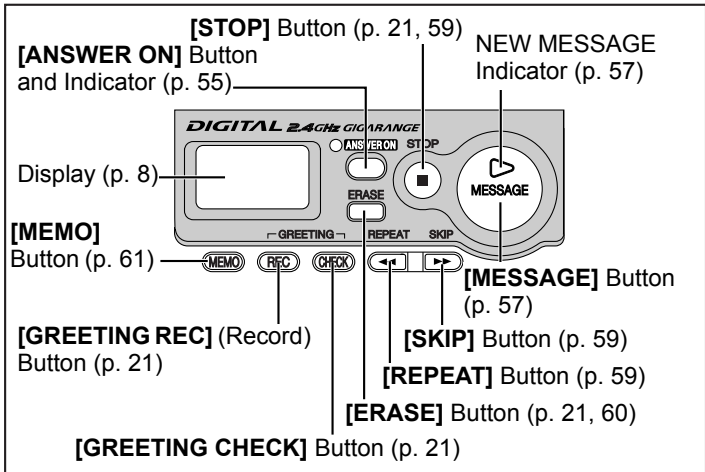

Location of Controls

Handset

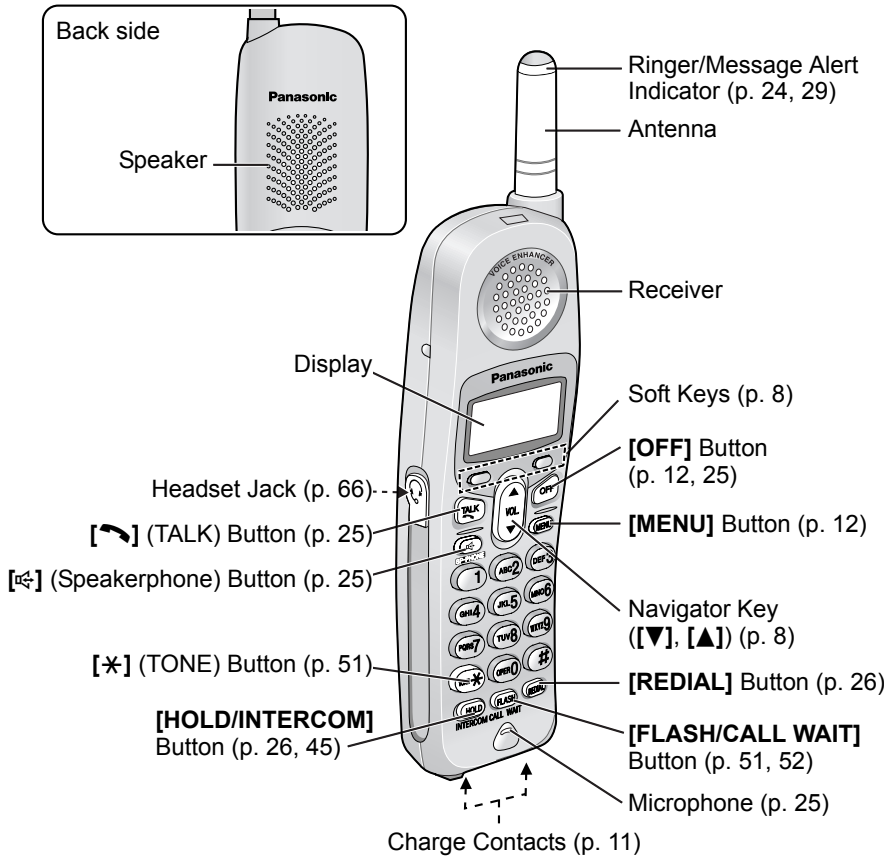

Charger unit

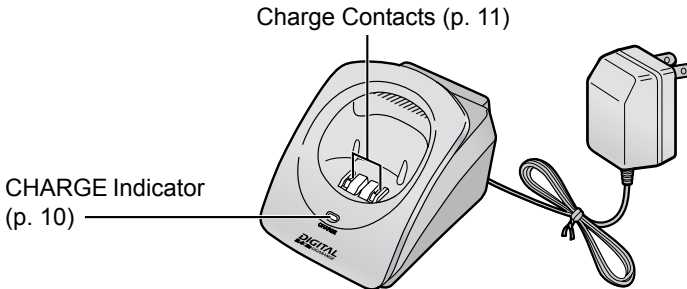

This unit includes two handsets and one base unit. The included handsets are pre-registered at the factory and assigned the extension numbers 1 and 2.

Location of Controls

Handset soft keys

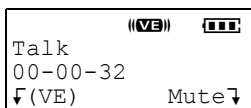

Pressing the right soft key selects mute "Mute".

Pressing the left soft key selects Voice Enhancer "VE".

- When a function name does not appear above a soft key, the soft key has no function.

Two soft keys are used to select functions displayed directly above each key. Functions displayed above the keys will change depending on the state of use.

On this sample display, "VE" and "Mute" are displayed above soft keys.

Handset navigator key



Scrolls up [▲] and down [▼] the function menu, the Caller List and the phone book.

Increases [▲] or decreases [▼] the handset ringer and receiver/speaker volumes.

Throughout these Operating Instructions:

- The soft keys are indicated by what is displayed above the keys.
Ex. "Press Mute." indicates "Press the soft key below Mute".
- The navigator key is indicated by the arrows [▼] or [▲].

Base unit display

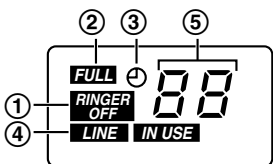

- ① "RINGER OFF" indicates the base unit ringer is off (p. 18).
- ② "FULL" flashes when no new messages can be recorded. Erase unnecessary messages (p. 60).
- ③ "⌚" flashes until you set the date and time, and flashes after a power failure. If it is flashing, set the date and time (p. 14).

- ④ "LINE IN USE" functions as follows.

Off (invisible)	The line is free.
On	The line is being used.
Flashing	A call is on hold on the handset or base unit or the Answering System is answering a call (p. 55).
Flashing rapidly	A call is being received.

- "IN USE" displays when a handset is operating the Answering System.

- ⑤ Message counter shows:

- the total number of recorded messages. If the recording time is set to "Greeting only", "99" will be displayed (p. 22).
- the selected volume level while you are adjusting the volume (p. 21, 28).
- "E" when your greeting message or memo message was not recorded correctly (p. 21, 61).

Installation

Connections

Base unit

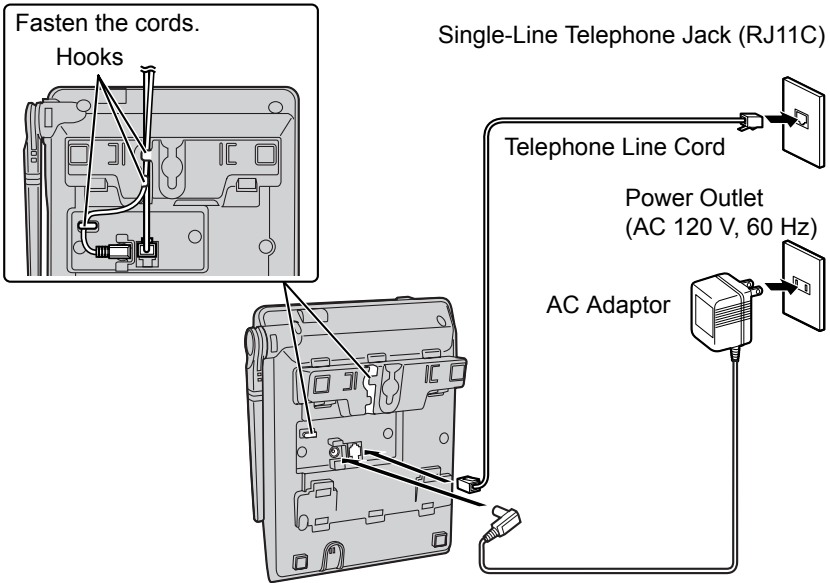

- Base Unit: USE ONLY WITH Panasonic AC ADAPTOR PQLV1 (Order No. PQLV1Z).
- The AC adaptor must remain connected at all times. (It is normal for the adaptor to feel warm during use.)
- If your unit is connected to a PBX which does not support Caller ID, you cannot access Caller ID services.
- The unit will not work during a power failure. We recommend connecting a standard telephone to the same telephone line or to the same telephone jack using the Panasonic KX-J66 T-adaptor.

Charger unit

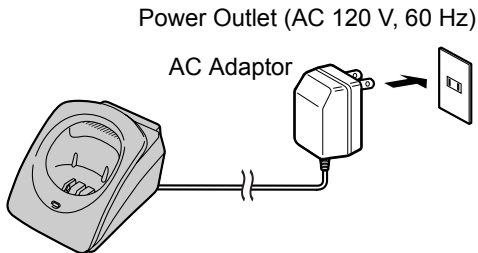

- Charger unit: USE ONLY WITH Panasonic AC ADAPTOR KX-TCA1 (Order No. KX-TCA1-G).
- The AC adaptor must remain connected at all times. (It is normal for the adaptor to feel warm during use.)

Installation

Installing the Battery in the Handset

Insert the battery (①), and press it down until it snaps into the compartment (②). Close the cover.

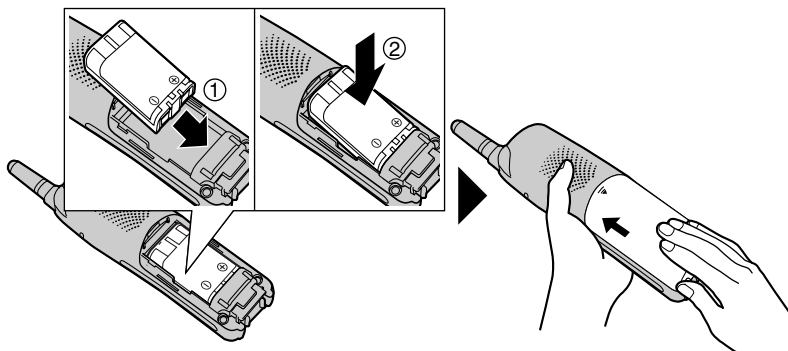

To replace the battery:

Press the notch on the cover firmly and slide it as indicated by the arrow. Replace the old battery with a new one (p. 11). Close the cover and charge the battery for 6 hours.

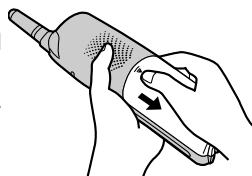

Battery Charge

Place the handsets on the base unit and charger. Charge for **6 hours** before initial use.

- The unit beeps once, the CHARGE indicator lights, and “Charging” is displayed.
- When the battery is fully charged, “Charge completed” is displayed.

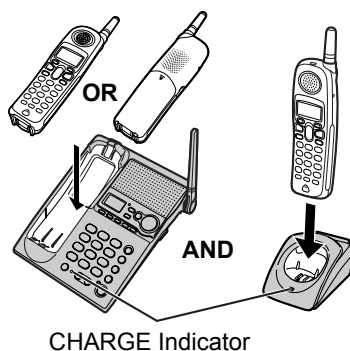

Battery strength

You can confirm battery strength on the handset display. Battery strength is indicated by the icons shown in the chart to the right.



Display prompt	Battery strength
	Fully charged
	Medium
	Low
(flashing)	Needs to be recharged.
	Discharged

Recharge

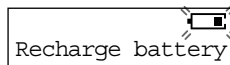

Recharge the battery when:

- “Recharge battery” is displayed on the handset,
- “” flashes, or
- the handset beeps intermittently while it is in use.



- The display will continually indicate “Recharge battery” and/or “” will flash when the handset battery is charged for less than 15 minutes and the handset is lifted off the base unit or charger.
- If the battery has been discharged, the handset will display “Charge for 6h” and “” when you place the handset on the base unit or charger. The handset will not work unless the battery is charged. Continue charging.

Battery replacement:

If you cleaned the charge contacts and fully charged the battery, but after a few telephone calls, “Recharge battery” is displayed and/or “” continues to flash, or “Charge for 6h” and “” are displayed, the battery may need to be replaced. Please order a new Panasonic HHR-P104 battery at the telephone number shown on page 2. To replace the battery, see page 10.

A nickel metal hydride battery that is recyclable powers the product you have purchased. Please call 1-800-8-BATTERY for information on how to recycle this battery.



Battery information

After your Panasonic battery is fully charged, you can expect the following performance:

Operation	Operating time
While in use (TALK)	Up to 5 hours
While not in use (Standby)	Up to 11 days

- A fully charged battery will give you up to 5 hours of continuous talk time, or keep your handset in Standby mode to receive incoming calls for up to 11 days (if no phone calls are made). Battery power is consumed whenever the handset is off of the base unit or charger, even when the handset is not in use. The longer you leave the handset off of the base unit or charger, the time you can actually talk on the handset will be shortened. Actual battery performance depends on a combination of how often the handset is in TALK mode and how often it is in Standby mode.
- If the battery is fully charged, you do not have to place the handset on the base unit or charger until “Recharge battery” is displayed and/or “” flashes. This will maximize the battery life.
- If you want to keep the battery fully charged at all times, place the handset on the base unit or charger when the handset is not used. The battery cannot be overcharged.
- **Clean the charge contacts of the handset, the base unit and the charger with a soft, dry cloth once a month. Clean more often if the unit is subject to grease, dust or high humidity.** Otherwise the battery may not charge properly.

Programmable Settings

Programming Guidelines **Handset**

This unit has several programmable functions which can be selected from the function menu on the display (p. 13).

The **soft keys** selects the functions displayed above each soft key.

When “▼” or “▲” is displayed, navigator key scrolls through the menu.

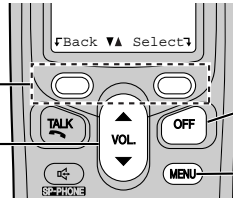

[OFF] exits programming.

[MENU] enters the function menu.

How to select a function item from the menu

Make sure the handset and base unit are not being used. The handset must be operated near the base unit and while off the base unit or charger.

1 Press **[MENU]**.

- The main menu is displayed (p. 13).

2 Scroll to the desired item by pressing **[▼]** or **[▲]**.



3 Press **select** to select the desired item.



4 If the item has a sub-menu, select the menu item (p. 13). Repeat steps 2 and 3 until the desired item is displayed. If the item has no sub-menu, go to step 5.

5 Select the desired setting by pressing **[▼]** or **[▲]**, then press **save** to save your setting.

- A confirmation tone will be heard and the setting will be saved.



6 Press **[OFF]** to exit programming mode.

- To go back to the previous menu, press **Back**, or press **Select** while “--- (Go back) ---” is displayed. If you press this key in the main menu, the unit will exit programming mode.
- After programming is complete, the display will return to the main menu or the sub-menu depending on which menu the selected item is located. (See the menu table on page 13.)
- You can exit programming mode at any time by pressing **[OFF]**.
- If you do not press any buttons for 60 seconds, the handset will exit programming mode.
- If the unit detects a problem, an error message will be displayed (p. 71–72) and/or error beeps will sound.

Programmable Settings

Function Menu Table **Handset**

You can use the following functions to customize your unit. See the corresponding pages for function details.

- After pressing **[MENU]**, you can also program menu items directly by pressing (**[0]** to **[9]**, **[*]** and **[#]**) instead of using the soft keys (p. 69–70).

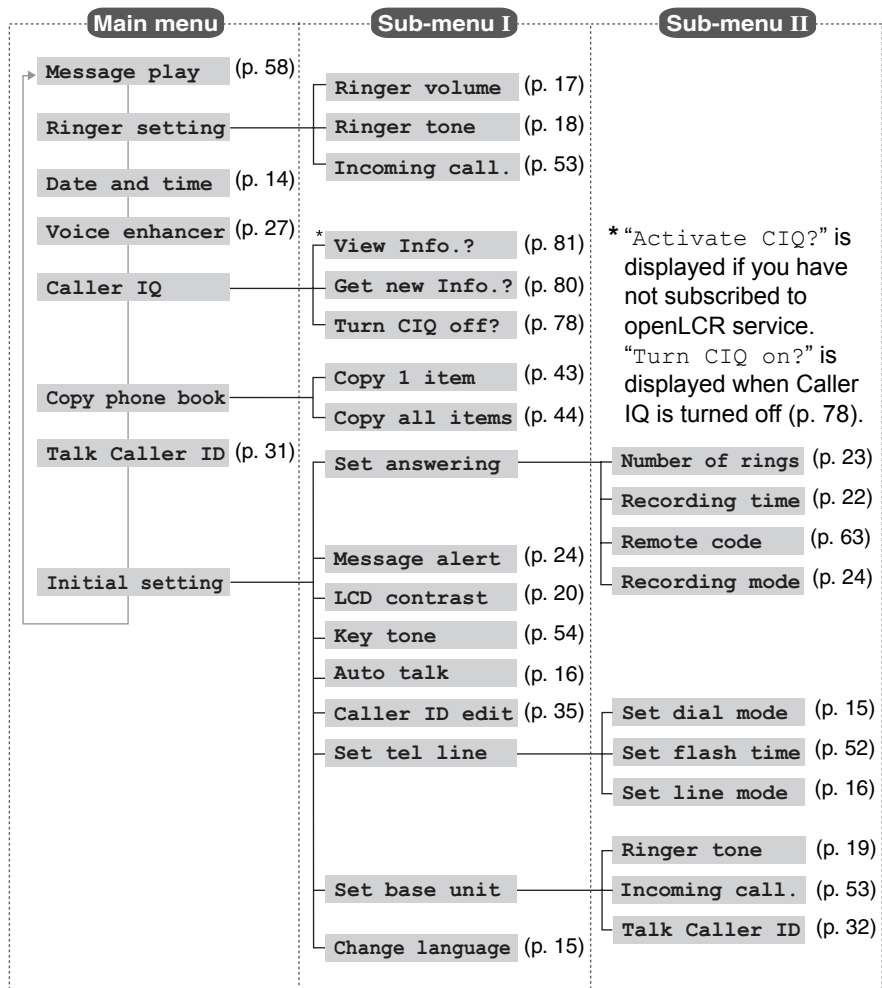

- If you program the date and time, dialing mode, flash time, line mode, number of rings, recording time, recording mode or the remote code using one of the handsets, you will not need to program the same item using another handset.

Programmable Settings

Date and Time **Handset**

We recommend you set the date and time so that the unit will announce the day and time each message was recorded when you play back messages.

1 Press **[MENU]**.

2 Scroll to "Date and time" by pressing **[▼]** or **[▲]**, then press **Select**.

Date and time
↓Back ▲Select↓

3 ① Enter 2 digits each for the month, day, and year. (Ex. To set May 15, 2004, enter "05 15 04".)

Date: 12.31.2004
Time: 12:00 AM
↓AM/PM Save↓

② Enter 4 digits for the time (hour and minute). (Ex. To set 9:30, enter "0930".)

Example
Date: 05.15.2004
Time: 09:30 AM
↓AM/PM Save↓

• If you enter a wrong number, press **[▼]** or **[▲]** to move the cursor to the incorrect number. Enter the correct number.

4 Select "AM" or "PM" by pressing **AM/PM**.

Date: 05.15.2004
Time: 09:30 AM
↓AM/PM Save↓

5 Press **Save**.

- The date and time are set and "⓪" disappears from the base unit display.
- If the handset beeps 3 times, the date and time were not set correctly. Start again from step 3.

6 Press **[OFF]**.

• When entering the time in step 3, you cannot enter numbers greater than 12. **Do not use military time.** (To set 13:00 hours, enter "0100", then select "PM" in step 4.)

The date and time may be incorrect after a power failure. When "⓪" flashes on the base unit display, set the date and time again.

To confirm the date and time, repeat steps 1 and 2 above.

• The current date and time are displayed. When finished, press **[OFF]**.

For Caller ID service users (p. 30)

- When a call is received, Caller ID information adjust the date and time if the time is incorrect.
- Caller ID information will automatically adjust the date and time for daylight saving time.
- If the date and time have not previously been set, Caller ID information will not adjust the date and time.

Programmable Settings

Display Language **Handset**

You can select either “English” or “Spanish” as the display language. The factory preset is “English”.

1 Press **[MENU]**.

2 Scroll to “Initial setting” by pressing **[▼]** or **[▲]**, then press **Select**.

Initial setting
└Back ▼▲ Select┘

3 Scroll to “Change language” by pressing **[▼]** or **[▲]**, then press **Select**.

Change language
└Back ▼▲ Select┘

4 To change from English to Spanish, press **Español**.

To change from Spanish to English, press **English**.

- The display changes to the selected language.
- You can also select a language by pressing **[▼]** or **[▲]**.

Display
:English
└Español Save┘

5 When Spanish is selected, press **Salvar**, then press **[OFF]**.
When English is selected, press **Save**, then press **[OFF]**.

- If you select a language you cannot read, change the display language again using direct commands (p. 70).

Dialing Mode **Handset**

If you have touch tone service, set the dialing mode to “Tone”. For rotary or pulse service, set to “Pulse”. The factory preset is “Tone”.

1 Press **[MENU]**.

2 Scroll to “Initial setting” by pressing **[▼]** or **[▲]**, then press **Select**.

Initial setting
└Back ▼▲ Select┘

3 Scroll to “Set tel line” by pressing **[▼]** or **[▲]**, then press **Select**.

Set tel line
└Back ▼▲ Select┘

4 Press **Select** at “Set dial mode”.

Set dial mode
└Back ▼▲ Select┘

5 Select “Pulse” or “Tone” by pressing **[▼]** or **[▲]**.

Set dial mode
:Tone
└Back ▼▲ Save┘

6 Press **Save**, then press **[OFF]**.

Programmable Settings

Line Mode **Handset**

The line mode is preset to “B” and generally should not be adjusted. If “Line in use” on the handset and “**LINE IN USE**” on the base unit are not displayed properly, the line mode selection is incorrect. Set line mode to “A”.

1 Press **[MENU]**.

2 Scroll to “Initial setting” by pressing **[▼]** or **[▲]**, then press **Select**.

```
Initial setting
↓Back ▼▲ Select↓
```

3 Scroll to “Set tel line” by pressing **[▼]** or **[▲]**, then press **Select**.

```
Set tel line
↓Back ▼▲ Select↓
```

4 Scroll to “Set line mode” by pressing **[▼]** or **[▲]**, then press **Select**.

```
Set line mode
↓Back ▼▲ Select↓
```

5 Select “A” or “B” by pressing **[▼]** or **[▲]**.

```
Set line mode
:B
↓Back ▼▲ Save↓
```

6 Press **save**, then press **[OFF]**.

Auto Talk **Handset**

The Auto Talk feature allows you to answer calls by simply lifting the handset off the base unit or charger. You do not need to press **[📞]** or **[📞]**. The factory preset is OFF.

1 Press **[MENU]**.

2 Scroll to “Initial setting” by pressing **[▼]** or **[▲]**, then press **Select**.

```
Initial setting
↓Back ▼▲ Select↓
```

3 Scroll to “Auto talk” by pressing **[▼]** or **[▲]**, then press **Select**.

```
Auto talk
↓Back ▼▲ Select↓
```

4 Select “On” or “Off” by pressing **[▼]** or **[▲]**.

```
Auto talk
:Off
↓Back ▼▲ Save↓
```

5 Press **save**, then press **[OFF]**.

- In order to view Caller ID information after you lift the handset to answer a call, leave the Auto Talk feature turned off.

Ringer Volume

You can select the handset or base unit ringer volumes to high, medium, low, or off. The factory preset is HIGH. If the handset and base unit ringer is turned off, the handset or base unit will ring at the low level for intercom calls, and will not ring for outside calls. Caller names will not be announced even if the Talking Caller ID feature is turned on (p. 31, 32).

Handset ringer volume **Handset**

1 Press **[MENU]**.

2 Scroll to “Ringer setting” by pressing **[▼]** or **[▲]**, then press **Select**.

```
Ringer setting
┆Back ▼▲ Select┆
```

3 Press **select** at “Ringer volume”.

```
Ringer volume
┆Back ▼▲ Select┆
```

4 Select the desired volume level by pressing **[▼]** or **[▲]**.

- The volume will change and ring.
- The number of steps indicates the volume level.
- **To turn the ringer off**, press **[▼]** repeatedly until “Off ?” is displayed.

```
Ex. High
Ringer volume
Low ██████ High
┆Back ▼▲ Save┆
```

5 Press **save**.

- If the handset ringer is turned off, “Ringer off” will be displayed while not in use. If the handset is off the base unit or charger when there are missed calls or new messages (p. 58), “Ringer off” is not displayed.
- You can adjust the ringer volume while an outside call is ringing. Press **[▼]** or **[▲]** while the handset is ringing.

Temporary ringer off

While the handset is ringing for an outside call, you can turn the ringer off temporarily by pressing **[OFF]**. The handset will ring again as normal the next time a call is received.

Programmable Settings

Base unit ringer volume **Base Unit**

Make sure the base unit is not being used.

To set the ringer volume to high (preset), medium, or low, press **VOLUME [V]** or **[^]**.

- To increase volume, press **VOLUME [^]**.
To decrease volume, press **VOLUME [V]**.
- To stop ringing, press **[STOP]**.

To turn the ringer off, press and hold **VOLUME [V]** until 2 beeps sound.

- “**RINGER OFF**” is displayed.

To turn the ringer on, press **VOLUME [V]** or **[^]**.

- The base unit will ring at the low level.
- You can adjust the ringer volume while an outside call is ringing.
Press **VOLUME [V]** or **[^]** while the base unit is ringing.
To turn the ringer off, press and hold **VOLUME [V]** until 2 beeps sound.
“**RINGER OFF**” is displayed.

Ringer Tone

You can set the handset and base unit ringers to use one of 7 ringer patterns for outside calls. “Tone 1” to “Tone 3” are bell ringer patterns. “Melody 1” to “Melody 4” are preset melody patterns. The factory preset is “Tone 1”.

- You cannot change the ringer tone for intercom calls.
- If you subscribe to a Distinctive Ring Service (such as IDENTIA-RING) from your telephone company with 2 or 3 consecutive rings, select a bell ringer pattern (Tone 1 to 3). If you select a melody pattern, you will not be able to distinguish lines by their ringers.
- If you select one of the melody ringer patterns, the ringer will continue to sound for several seconds if:
 - the caller hangs up before you answer the call, or
 - another person answers the call using another phone connected on the same line.

Handset ringer tone **Handset**

1 Press **[MENU]**.

2 Scroll to “Ringer setting” by pressing **[▼]** or **[▲]**, then press **Select**.

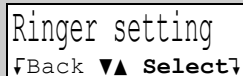

Ringer setting
└Back ▼▲ Select┘

3 Scroll to “Ringer tone” by pressing **[▼]** or **[▲]**, then press **Select**.

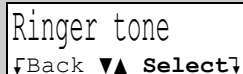

Ringer tone
└Back ▼▲ Select┘

4 Select the desired ringer tone by pressing [▼] or [▲].

- The handset will ring and the ringer tone will change. If the ringer volume has been turned off, the handset will not ring (p. 17).
- You can also select the ringer tone by pressing [1] to [7].

```
Ringer tone
1:Tone 1
↓Back  ▼▲  Save↓
```

5 Press **save**, then press [OFF].

Base unit ringer tone (use either the handset or the base unit)

Base Unit

Make sure the base unit is not being used.

Press **VOLUME** [V] or [^], then select the desired ringer tone by pressing [1] to [7].

[1] to [3] : Bell ringer patterns [4] to [7] : Melody patterns

- After pressing **VOLUME** [V] or [^], the base unit will ring using the current ringer tone.
- The base unit will ring and the ringer tone will change.
- To stop ringing, press [STOP].

Setting the base unit ringer tone by using the Handset

1 Press [MENU].

2 Scroll to “Initial setting” by pressing [▼] or [▲], then press **Select**.

3 Scroll to “Set base unit” by pressing [▼] or [▲], then press **Select**.

4 Press **Select** at “Ringer tone”.

5 Select the desired ringer tone by pressing [▼] or [▲].

- The base unit will ring and the ringer tone will change. If the base unit ringer volume has been turned off, the base unit will not ring (p. 18).
- You can also select the ringer tone by pressing [1] to [7].

6 Press **save**, then press [OFF].

Programmable Settings

LCD Contrast **Handset**

There are 6 levels of LCD contrast. The factory preset is “level 3”.

1 Press **[MENU]**.

2 Scroll to “Initial setting” by pressing **[▼]** or **[▲]**, then press **Select**.

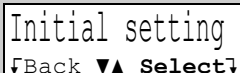

Initial setting
└Back ▼▲ Select┘

3 Scroll to “LCD contrast” by pressing **[▼]** or **[▲]**, then press **Select**.



LCD contrast
└Back ▼▲ Select┘

4 Select the desired contrast by pressing **[▼]** or **[▲]**.

- The contrast will change.

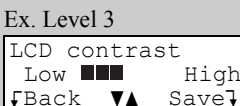

Ex. Level 3
LCD contrast
Low ■■■ High
└Back ▼▲ Save┘

5 Press **save**, then press **[OFF]**.

Preparing the Answering System

Greeting Message **Base Unit**

You can record a personal greeting message of **up to 2 minutes**. If you do not record your own message, one of two pre-recorded greetings will be played for callers (p. 22).

The total recording time of all messages (greeting, incoming and memo) is **about 16 minutes**.

We recommend you record a **brief greeting message** in order to leave more time for recording new messages.

- You can use the enhanced recording mode for clearer sound, if necessary (p. 24).

Preparing the Answering System

To record a greeting message

Sample greeting message

“Hello, this is (your name and/or number). Sorry, I cannot take your call. Please leave a message after the beep. Thank you.”

- 1 Press **[GREETING REC]**.
 - “To record greeting, press RECORD again” is heard.
- 2 Within 10 seconds, press **[GREETING REC]** again to record your greeting.
- 3 After the long beep, talk clearly, about 20 cm (8 inches) away from the **MIC** (microphone).
 - The elapsed recording time is displayed.
 - If you record for over 2 minutes, the unit will stop recording.
- 4 When finished, press **[GREETING REC]** or **[STOP]**.
 - To change the greeting, start again from step 1.

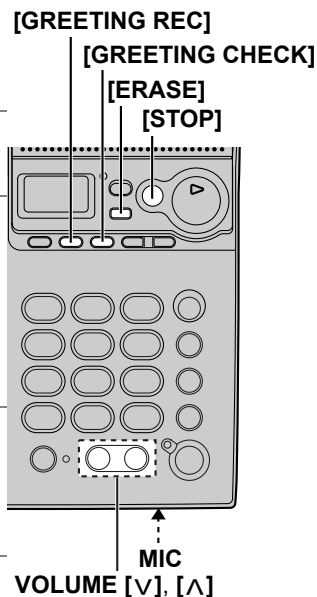

- If “E” is displayed, 6 beeps sound and “Your greeting was not recorded. Record your greeting again.” is announced, start again from step 1.

To adjust the speaker volume, press VOLUME [V] or [^] during playback.

- 9 levels (0–8) are available while using the Answering System. The level is displayed on the base unit.

To review the greeting

Press **[GREETING CHECK]**.

To erase the greeting

Press **[GREETING CHECK]**, then press **[ERASE]** while the recorded message is being played.

- The unit will answer calls with a pre-recorded greeting (p. 22).

Preparing the Answering System

Pre-recorded greeting

If you do not record a greeting (p. 20, 21), one of two greetings will be played when a call is received, depending on the caller's recording time (see below).

To review the pre-recorded greeting, press [GREETING CHECK].

- A pre-recorded greeting will be played as follows:
 - When the recording time is set to "1 minute", "2 minutes" or "3 minutes":
"Hello, we are not available now. Please leave your name and phone number after the beep. We will return your call."
 - If recording time runs out, the unit will automatically switch to the "Greeting only" mode (see below), and no new messages will be recorded.
 - When the recording time is set to "Greeting only":
"Hello, we are not available now. Please call again. Thank you for your call."

Flash Memory Message Backup (Message storage)

Messages stored in memory will not be affected by power failures. All messages are saved until you erase them.

Caller's Recording Time **Handset**

You can select "1 minute", "2 minutes", "3 minutes" or "Greeting only" for the caller's recording time. The factory preset is "3 minutes".

1 Press **[MENU]**.

2 Scroll to "Initial setting" by pressing **[▼]** or **[▲]**, then press **Select**.

Initial setting
↓Back ▼▲ Select↓

3 Press **Select** at "Set answering".

Set answering
↓Back ▼▲ Select↓

4 Scroll to "Recording time" by pressing **[▼]** or **[▲]**, then press **Select**.

Recording time
↓Back ▼▲ Select↓

5 Select the recording time by pressing **[▼]** or **[▲]**.

- You can also select the recording time by pressing **[1]**, **[2]**, **[3]** or **[0]** (Greeting only).

Recording time
:3min
↓Back ▼▲ Save↓

6 Press **save**, then press **[OFF]**.

Preparing the Answering System

If you select "Greeting only", the unit will answer calls with the greeting message, and then hang up. The unit will not record any incoming messages. The base unit will display "g" instead of the number of messages.

Number of Rings **Handset**

You can select the number of times the unit rings before the Answering System answers a call, from "2" to "7" or "Toll saver"*. The factory preset is "4".

1 Press **[MENU]**.

2 Scroll to "Initial setting" by pressing **[▼]** or **[▲]**, then press **Select**.

Initial setting
fBack ▼▲ Selectf

3 Press **select** at "Set answering".

Set answering
fBack ▼▲ Selectf

4 Press **select** at "Number of rings".

Number of rings
fBack ▼▲ Selectf

5 Select the number of rings by pressing **[▼]** or **[▲]**.

- You can also select the number of rings by pressing **[0]** (Toll saver*), or **[2]** to **[7]**.

Number of rings
:4
fBack ▼▲ Savef

6 Press **save**, then press **[OFF]**.

*Toll saver

When you call the unit from a remote operation, the number of rings will tell you if there are any new messages. If the unit answers on the 2nd ring, there is at least one new message. If the unit answers on the 4th ring, there are no new messages. To save the toll charges for the call, hang up immediately when you hear the 3rd ring. The 3rd ring indicates that there are no new messages.

Preparing the Answering System

Recording Mode **Handset**

Two recording modes are available. The factory preset is “Standard recording (16min)”, which provides more recording time (16min) and standard sound quality. “Enhanced recording (8 min)” provides less recording time (8 min) but clearer sound quality.

1 Press **[MENU]**.

2 Scroll to “Initial setting” by pressing **[▼]** or **[▲]**, then press **Select**.

3 Press **Select** at “Set answering”.

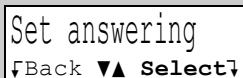

Set answering
Back Select

4 Scroll to “Recording mode” by pressing **[▼]** or **[▲]**, then press **Select**.



Recording mode
Back Select

5 Select the recording mode by pressing **[▼]** or **[▲]**.

- You can also select the recording mode by pressing **[1]** (Standard) or **[2]** (Enhanced).

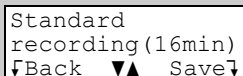

Standard
recording (16min)
Back Save

6 Press **save**, then press **[OFF]**.

Message Alert **Handset**

You can select whether or not the Ringer/Message Alert indicator on the handset will flash slowly when new messages have been recorded (p. 58). The factory preset is OFF.

1 Press **[MENU]**.

2 Scroll to “Initial setting” by pressing **[▼]** or **[▲]**, then press **Select**.

3 Scroll to “Message alert” by pressing **[▼]** or **[▲]**, then press **Select**.



Message alert
Back Select

4 Select “On” or “Off” by pressing **[▼]** or **[▲]**.

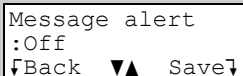

Message alert
:Off
Back Save

5 Press **save**, then press **[OFF]**.

- The Ringer/Message Alert indicator will not flash for new messages while the handset is in use.
- The Ringer/Message Alert indicator acts both as a ringer indicator and as a message alert indicator. This indicator will flash rapidly when a call is received whether this feature is on or off.
- Battery operating time will be shortened when using this feature (p. 11).

Making Calls

Using the Handset **Handset**

- 1 Press [📞].
 - “Talk” is displayed.
- 2 Dial a phone number.
 - The dialed number is displayed.
 - After a few seconds, the display will show the length of the call.
- 3 To hang up, press [OFF] or place the handset on the base unit or charger.

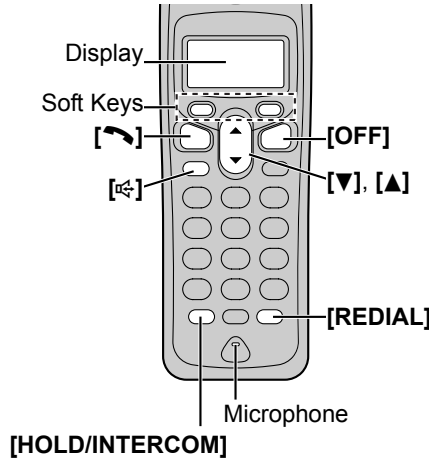

To have a hands-free phone conversation

- 1 Press [📞].
 - “SP-phone” is displayed.
- 2 Dial a phone number.
 - The dialed number is displayed.
 - After a few seconds, the display will show the length of the call.
- 3 When the other party answers, talk into the microphone.
- 4 To hang up, press [OFF] or place the handset on the base unit or charger.

Hands-free Digital Duplex Speakerphone

For best performance, please note the following:

- Talk alternately with the other party in a quiet room.
- If you or the other party has difficulty hearing, press [▼] to decrease the speaker volume.
- While talking using [📞], you can switch to a hands-free phone conversation by pressing [📞]. To switch back to the receiver, press [📞].

Making Calls

To dial after confirming the entered number

1 Enter a phone number.

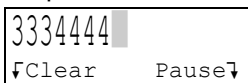

- If you misdial, press **Clear**. Enter the correct number.
- If a pause is required when dialing, press **Pause** where needed (p. 52).
- To cancel, press **[OFF]**.

2 Press [**↶**] or [**↷**].

3 To hang up, press **[OFF]** or place the handset on the base unit or charger.

To adjust the receiver/speaker volume during a conversation

There are 3 volume levels for the receiver and 6 volume levels for the speaker.

To increase volume, press [**▲**].

To decrease volume, press [**▼**].

Ex. Receiver volume: High
Speaker volume: Level 6



- The display shows the current volume setting.
- If you try to increase/decrease volume when it is at the maximum/minimum level, the handset will beep 3 times.

To redial the last number dialed

Press [**↶**] or [**↷**], then press **[REDIAL]**.

To redial using the redial list (Memory Redial)

The last 5 phone numbers dialed are stored in the redial list.

1 Press **[REDIAL]**.



- The last number dialed is displayed.

2 Scroll to the desired number by pressing [**▼**] or [**▲**].

- You can also scroll down through the list by pressing **[REDIAL]**.
- To exit the list, press **[OFF]**.

3 Press [**↶**] or [**↷**].

- **To erase an item**, scroll to the item then press **Erase**.
- If “No items stored” is displayed, the list is empty.

To put a call on hold

1 Press **[HOLD/INTERCOM]** during a conversation.

- “Line on hold.” is displayed.
- To transfer the call to the base unit or another handset, see pages 48–49.

2 Press **[HOLD/INTERCOM]** again.

- “Hold” is displayed.

To return to the call, press [**↶**] or [**↷**].

- The base unit user can also take the call by pressing **[SP-PHONE]**. Another handset user can also take the call by pressing [**↶**] or [**↷**].
- If another phone is connected on the same line (p. 9), you can also take the call by lifting its handset.
- If a call is kept on hold for 6 minutes, an alarm tone will start to sound and the Ringer/Message Alert indicator will start to flash rapidly. After 4 additional minutes on hold, the call will be disconnected.

Voice Enhancer Technology

Panasonic's Voice Enhancer Technology clarifies the voice of the person you are talking to, reproducing a more natural-sounding voice that is easier to hear and understand.

Voice Enhancer Technology can be turned on or off. The factory preset is OFF.

- Depending on the condition and quality of your telephone line, this feature may emphasize existing line noise. If it becomes difficult to hear, turn this feature off.

To turn this feature on, press (VE) during a conversation.

- “(VE)” is displayed.
- **To turn this feature off**, press (VE) again. “(VE)” disappears from the display.
- After hanging up a call, the on/off setting will be retained.

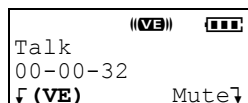

When the handset is not in use, you can also turn this feature on or off by programming as follows:

1. Press **[MENU]**.
2. Scroll to “Voice enhancer” by pressing **[▼]** or **[▲]**, then press **Select**.
3. Select “On” or “Off” by pressing **[▼]** or **[▲]**.
4. Press **save**, then press **[OFF]**.

Backlit LCD display/Lighted handset keypad

The handset display and dialing buttons will light for a few seconds after pressing a button or lifting the handset off the base unit or charger. They will also light when an intercom/outside call is being received.

Making Calls

Using the Base Unit **Base Unit**

- 1 Press **[SP-PHONE]**.
 - The SP-PHONE indicator lights.
- 2 Dial a phone number.
- 3 When the other party answers, talk into the **MIC** (microphone).
- 4 To hang up, press **[SP-PHONE]**.
 - The indicator light goes out.

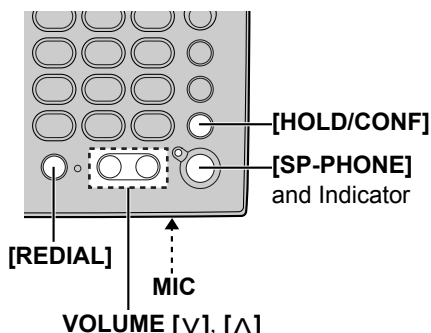

- To switch to the handset while using the base unit speakerphone:
 - If the handset is off the base unit or charger, press **[↶]** or **[↷]** on the handset, then press **[SP-PHONE]** on the base unit.
 - If the handset is on the base unit, just lift up.

Hands-free Digital Duplex Speakerphone

For best performance, please note the following:

- **Talk alternately with the other party in a quiet room.**
- If you or the other party has difficulty hearing, press **VOLUME [V]** to decrease the speaker volume.

To adjust the speaker volume during a conversation

To increase volume, press **VOLUME [^]**.

To decrease volume, press **VOLUME [V]**.

- There are 8 volume levels. If you try to increase/decrease volume when it is at the maximum/minimum level, the base unit will beep 3 times.

To redial the last number dialed

Press **[SP-PHONE]**, then press **[REDIAL]**.

To put a call on hold

Press **[HOLD/CONF]** during a conversation.

- The SP-PHONE indicator flashes.

To return to the call, press [SP-PHONE].

- The handset user can also take the call by pressing **[↶]** or **[↷]**.
- If another phone is connected on the same line (p. 9), you can also take the call by lifting its handset.
- If a call is kept on hold for 6 minutes, an alarm tone will start to sound. After 4 additional minutes on hold, the call will be disconnected.

Answering Calls

When a call is received, the unit rings, "Incoming call" is displayed, and the Ringer/Message Alert indicator on the handset and "LINE IN USE" on the base unit flash rapidly.

If you subscribe to Caller ID, see page 30.

Handset

- 1 Press [📞] or [📞].
 - You can also answer a call by pressing any button except [▼], [▲] or [OFF].
- 2 To hang up, press [OFF] or place the handset on the base unit or charger.

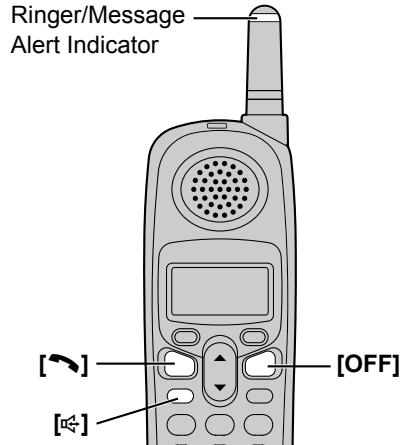

Auto Talk

If the Auto Talk feature is turned on (p. 16), you can answer a call by simply lifting the handset off the base unit or charger.

Temporary ringer off

You can turn the ringer off temporarily by pressing [OFF], while the handset is ringing for an outside call. The handset will ring again as normal the next time a call is received.

Base Unit

- 1 Press [SP-PHONE].
- 2 Talk into the MIC.
- 3 To hang up, press [SP-PHONE].

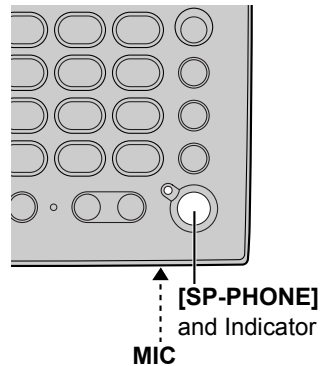

- To transfer the call to another person, see pages 48–49.
- If the ringer volume is turned off, the unit will not ring (p. 17, 18).

Caller ID Service

This unit is compatible with Caller ID services offered by your telephone company. If you subscribe to Caller ID, caller names and phone numbers will be displayed and recorded in the Caller List.

How Caller ID information is displayed and announced

When a call comes in, the unit will ring and Caller ID information will be received. The handset display will show the caller's information, then the handset and base unit will announce the displayed name (ex. "Call from ROBINSON, TINA") following every ring (**Talking Caller ID feature**, p. 31).

Example

ROBINSON, TINA 1-555-222-3333

- After you answer the call, the display will show the length of the call.
- The handset and base unit announce the caller's name repeatedly until the call is answered.
- If the unit does not receive Caller ID information, one of the following will be displayed:

Display	Meaning
Out of area	The caller dialed from an area which does not provide Caller ID service.
Private caller	The caller requested not to send his/her information.
Long distance	The caller made a long distance call.

- Depending on the radio communications with the base unit, the handset may not display Caller ID information immediately after the first ring.
- If your unit is connected to a PBX which does not support Caller ID, you cannot access Caller ID service.
- Name display service may not be available in some areas. For further information, please contact your telephone company.
- If you subscribe to both Caller ID and Call Waiting with Caller ID services (CWID), when a second call is received while talking, a call waiting tone will be heard and the second caller's information will be displayed on the handset in use (p. 51). Contact your telephone company for details about availability in your area, and to verify that CWID is activated on your telephone line.

Talking Caller ID

To use this feature, you need to subscribe to Caller ID. For further information, please contact your telephone company.

- If the unit does not receive Caller ID information, the unit will announce “Call from out of area”, “Call from private caller”, or “Call from long distance”. If a call is received from an area where name display service is not available, “Number available” will be announced.
- If the ringer volume of the handsets and base unit is off, caller names will not be announced. The announcement is heard at the handset or base unit ringer volume (p. 17, 18).
- If this feature is not turned on, caller names will not be announced (see below, p. 32).
- If an outside call is received while on an intercom call between the handset and base unit, the other handset will ring, but the caller’s name will not be announced.
- If you have Call Waiting service, the second caller’s information will be displayed but not announced (For Call Waiting Service Users, page 51).
- Name pronunciation may vary. Name pronunciation quality is based on names most commonly used in the United States.
- The unit will announce each letter of abbreviations, such as “Co.” and “Inc.”.
- Caller ID supports names of up to 15 letters. If the caller’s name has more than 15 letters, the name will not be displayed or announced correctly.
- If you subscribe to a Distinctive Ring Service (such as IDENT-A-RING) from your telephone company with 2 or 3 consecutive rings, your unit may mute one or more of the rings in order to announce the name of the caller.

To turn Talking Caller ID on or off

You can turn Talking Caller ID on or off for the handset and base unit separately. If this feature is off, the unit will not announce caller names. The factory preset is ON.

Handset Talking Caller ID feature **Handset**

1 Press **[MENU]**.

2 Scroll to “Talk Caller ID” by pressing **[▼]** or **[▲]**, then press **Select**.



Talk Caller ID
┆Back ▼▲ Select┆

3 Select “Off” or “On” by pressing **[▼]** or **[▲]**.



Talk Caller ID
:On
┆Back ▼▲ Save┆

4 Press **save**, then press **[OFF]**.

Caller ID Service

Base unit Talking Caller ID feature **Handset**

This feature must be turned on or off for the base unit by using the handset.

1 Press **[MENU]**.

2 Scroll to "Initial setting" by pressing **[▼]** or **[▲]**, then press **Select**.

```
Initial setting
└Back ▼▲ Select┘
```

3 Scroll to "Set base unit" by pressing **[▼]** or **[▲]**, then press **Select**.

```
Set base unit
└Back ▼▲ Select┘
```

4 Scroll to "Talk Caller ID" by pressing **[▼]** or **[▲]**, then press **Select**.

```
Talk Caller ID
└Back ▼▲ Select┘
```

5 Select "Off" or "On" by pressing **[▼]** or **[▲]**.

```
Talk Caller ID
:On
└Back ▼▲ Save┘
```

6 Press **save**, then press **[OFF]**.

Using the Caller List

The unit can record information up to 50 different callers and store this information in the Caller List. Caller information is sorted by the most recent call to the oldest. When the 51st call is received, the information from the 1st call is deleted.

The unit will also tell you how many calls you missed while you were out or unavailable to answer the phone.

Handset on the base unit or charger

```

[1]
2 missed calls ─── ①
Charging

```

① The display will show the number of calls you missed.

Handset off the base unit or charger

```

2 missed calls ─── ①
Rcvd Phone
└calls book┘
└──────────┘ ②

```

② Press **Rcvd calls** to review other calls logged in the Caller List.

- If there are no items in the Caller List, "Rcvd calls" will not be displayed.
- After viewing the missed call entries, "missed calls" will disappear from the display.

- When new messages have been recorded (p. 58), "New message" will be displayed in place of missed calls display.

Viewing the Caller List **Handset**

1 Press **Rcvd calls**, [**▼**], or [**▲**] to enter the Caller List.

Ex. 2 calls missed.

2 missed calls
Rcvd Phone
↓ calls book ↓

2 missed calls
▼▲=Scroll list
↓All erase

2 To search from the most recent call, press [**▼**]. To search from the oldest call, press [**▲**].

- The caller's name, number and the time and date of the call are displayed. Name and phone number are alternately displayed as shown on the right.

Example

SMITH, JACK
3:10P JUN.29
↓Erase Select↓



1-555-333-4444
3:10P JUN.29
↓Erase Select↓

3 Press [**OFF**] to exit the list.

- If there is no name information for a caller, the display will only show the phone number.
- Each handset has its own Caller List. If you viewed the Caller List or answered a call on one handset, the same information in the other handset will be displayed as "missed".
- If you do not press any buttons for 60 seconds, the unit will exit the Caller List.

What "✓" means

"✓" indicates you have already viewed this calling information or answered the call. If the same caller calls again, the call entry with the "✓" will be replaced with the new call entry.

SMITH, JACK
3:10P JUN.29 ✓

If a caller calls more than once

The number of times the same caller called is displayed ("x2" to "x9"). The date and time of the most recent call will be recorded. After viewing a caller's information, "x2" to "x9" will be replaced with "✓".

Ex. Called 2 times.

TURNER, CINDY
11:20A JUN.12 x2

Calling Back from the Caller List **Handset**

1 Press **Rcvd calls**, [**▼**], or [**▲**] to enter the Caller List.

2 Scroll to the desired caller by pressing [**▼**] or [**▲**].

3 Press [**↶**] or [**↷**].

- The phone number is dialed.

- In some cases, you may have to edit the number before dialing (p. 34). (Ex. You may have to delete "1" and the area code.)
- If a phone number is not displayed in the caller information, you cannot call that caller back from the Caller List.

Using the Caller List

Editing the Caller's Phone Number **Handset**

You can edit a phone number in the Caller List by removing its area code and/or the long distance code "1".

Once you call back an edited number, this unit can automatically edit incoming phone numbers from the same area code in the Caller List and each time you receive a call (**Caller ID Number Auto Edit**, page 35).

1 Press **Rcvd calls**, [▼], or [▲] to enter the Caller List.

2 Scroll to the desired caller by pressing [▼] or [▲].

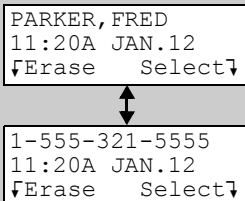

3 Press **Select**.

4 Press **Edit** repeatedly until the number is shown in the desired format.

- Each time you press **Edit**, the number is rearranged into one of 3 patterns.

- (a) Phone no.
- (b) Area code — Phone no.
- (c) 1— Area code — Phone no.

- The order in which patterns (a)– (c) are displayed depends on how the telephone number is displayed in step 2.

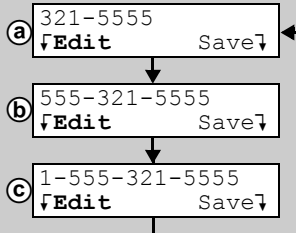

5 To call the edited number, press [↶] or [↷].

- If Caller ID Number Auto Edit is turned on (factory preset is on), phone numbers with the same area code as the number you edited will now be edited in the Caller List and each time you receive a call.
- You can press **[OFF]** immediately after pressing [↶] or [↷] if you wish to activate the Auto Edit feature without actually dialing the number you just edited.

To save the edited number into the phone book, press Save.

- If there is no name information, see "Storing Caller Information in the Phone Book" on page 36, from step 4.
- Even if the Auto Edit feature is turned on, this feature will not be activated by saving the edited number in the phone book.

Caller ID Number Auto Edit **Handset**

Once you call back an edited number (p. 34), this unit can automatically edit incoming phone numbers from the same area code in the Caller List and each time you receive a call. For example, it can ignore the area code of calls originating from your area code, so that you can call these numbers from the Caller List without dialing the area code.

To activate this feature, you must edit a caller's phone number in the Caller List (p. 34) by selecting pattern Ⓐ, Ⓑ, or Ⓒ, then make a call to that number. Calls from numbers in that area code will be edited automatically. The unit can remember up to 4 area codes to be edited according to patterns Ⓐ and Ⓑ.

When more than 5 area codes are edited, older area codes are reset to pattern Ⓒ. Phone numbers from the 4 most recently edited area codes will be automatically edited.

You can turn this feature on or off using the handset. The factory preset is ON.

To turn Caller ID Number Auto Edit on or off

1 Press **[MENU]**.

2 Scroll to "Initial setting" by pressing **[▼]** or **[▲]**, then press **Select**.



Initial setting
↓Back ▼▲ Select↓

3 Scroll to "Caller ID edit" by pressing **[▼]** or **[▲]**, then press **Select**.



Caller ID edit
↓Back ▼▲ Select↓

4 Select "Off" or "On" by pressing **[▼]** or **[▲]**.

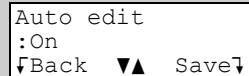

Auto edit
:On
↓Back ▼▲ Save↓

5 Press **save**, then press **[OFF]**.

- If you fail to reach your destination when making a call, the phone number you dialed might have an incorrect pattern. Edit the phone number with another pattern (p. 34).
- When this feature is turned off, the unit will still be able to display Caller ID, but incoming Caller ID numbers will not be automatically edited.
- If you move to another area, you may need to turn this feature off to erase the previously edited area codes. To use this feature again, turn it on and reprogram the area codes you want to edit once again.

Using the Caller List

Storing Caller Information in the Phone Book

Handset

Caller names and phone numbers that are in the handset Caller List can be stored in each handset's phone book.

- 1 Press **Rcvd calls**, **[▼]**, or **[▲]** to enter the Caller List.

```
2 missed calls
Rcvd      Phone
↓calls    book ↓
```

```
2 missed calls
▼▲=Scroll list
↓All erase
```

- 2 Scroll to the desired caller by pressing **[▼]** or **[▲]**.

```
TURNER, CINDY
11:00A JUN.12 x3
↓Erase   Select↓
```



```
1-555-456-7890
11:00A JUN.12 x3
↓Erase   Select↓
```

- 3 Press **Select**.

- If the number requires editing, see page 34.

- 4 Press **Save**.

```
TURNER, CINDY
1-555-456-7890
↓Edit      Save↓
```

```
Enter name
█
▼=Next  ▶↓
```

```
CINDY TURNER
◀▶ ▼=Next ▶↓
```

- If there is no name information for the caller, "Enter name" will be displayed.
 - You can enter a name by performing the following steps:
 - (1) enter the name (p. 39),
 - (2) press **[▼]**, and
 - (3) press **Save**.
 - If a name is not required, press **[▼]**, then press **Save**.
- To continue storing other items, repeat from step 2.
- To exit programming mode, press **[OFF]**.

- You cannot store Caller List item in the phone book if a phone number is not displayed.

Erasing Caller Information **Handset**

To erase a specific caller

<p>1 Press Rcvd calls, [▼], or [▲] to enter the Caller List.</p>	<div style="border: 1px solid black; padding: 5px;"> 2 missed calls Rcvd Phone ↓calls book ↓ </div> <div style="border: 1px solid black; padding: 5px; margin-top: 5px;"> 2 missed calls ▼▲=Scroll list ↓All erase </div>
<p>2 Scroll to the desired caller by pressing [▼] or [▲], then press Erase.</p> <ul style="list-style-type: none"> • To erase other items, repeat step 2. • To exit the Caller List, press [OFF]. 	<div style="border: 1px solid black; padding: 5px;"> REAGAN, TOM 12:20A JUN.12 ↓Erase Select↓ </div> <div style="border: 1px solid black; padding: 5px; margin-top: 5px; text-align: center;"> Erased </div>

To erase all entries

Before erasing all entries, make sure that you have viewed all missed calls.

<p>1 Press Rcvd calls, [▼], or [▲] to enter the Caller List.</p>	<div style="border: 1px solid black; padding: 5px;"> [1] Rcvd Phone ↓calls book ↓ </div>
<p>2 Press All erase.</p>	<div style="border: 1px solid black; padding: 5px;"> 0 missed call ▼▲=Scroll list ↓All erase </div>
<p>3 Press Yes.</p> <ul style="list-style-type: none"> • All entries in your Caller List are erased. 	<div style="border: 1px solid black; padding: 5px;"> All erase? ↓No Yes↓ </div> <div style="border: 1px solid black; padding: 5px; margin-top: 5px; text-align: center;"> All erased </div>

• To cancel erasing, press **no** after step 2.

Phone Book

The handset can store up to 50 names and phone numbers in its phone book. You can make a call by selecting a name or number from the phone book, and copy phone book items from one handset to another (p. 43–44).

Storing Names and Numbers **Handset**

1 Press **Phone book**.

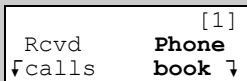

Rcvd [1]
Phone book

2 Press **Add**.

- The display will show the number of stored items.

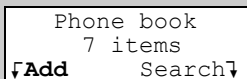

Phone book
7 items

3 Enter a name of up to 16 characters with the dialing buttons (**[0]** to **[9]**) (p. 39), then press **[▼]**.

- If a name is not required, press **[▼]** then go to step 4.

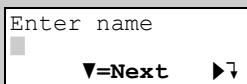

Enter name

▼=Next

Example ↓

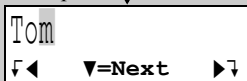

Tom

4 Enter a phone number of up to 32 digits.

- Each time you press **◀**, a digit is erased. To erase all of the digits, press and hold **◀**.
- If a pause is required when dialing, press **P**. A pause is stored in a phone number as one digit (p. 52).

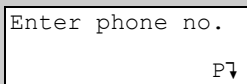

Enter phone no.

P

Example ↓

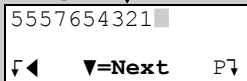

5557654321

5 Press **[▼]**.

- If you want to change the name, press **Edit**. The display returns to step 3. Change the name.
- If you want to change the number, press **[▲]**. The display returns to step 4. Change the number.

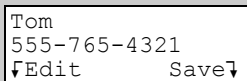

Tom
555-765-4321

6 Press **Save**.

- To continue storing other items, repeat from step 2.

7 Press **[OFF]**.

- To store numbers for calling card access (see “Chain Dial” on page 41), we recommend you add pauses after each item. Storing pauses with numbers will prevent misdialing (p. 52). The delay time necessary will depend on your telephone company.

Selecting characters to enter names

Enter names using the dialing buttons. Press each button until the desired character is displayed.

- Pressing each button selects a character in the order shown below.

Keys	Characters	Keys	Characters
[1]	# & ' () * , - . / 1	[6]	m n o M N O 6
[2]	a b c A B C 2	[7]	p q r s P Q R S 7
[3]	d e f D E F 3	[8]	t u v T U V 8
[4]	g h i G H I 4	[9]	w x y z W X Y Z 9
[5]	j k l J K L 5	[0]	0 Space
◀	Erases the character to the left.		
▶	Moves the cursor to the right. (To enter another character using the same number key, move the cursor to the next space.)		

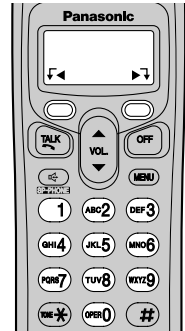

For example, to enter “Tom”:

- 1** Press [8] four times.

T

- 2** Press [6] three times, then press ▶ to move the cursor.

To

- 3** Press [6] once.

Tom

If you make a mistake when entering a name or number

Use ◀ to erase the incorrect character. Each time you press ◀, a character is erased. Re-enter the correct character. To erase all characters, press and hold ◀.

Phone Book

Dialing from the Phone Book **Handset**

1 Press **Phone book**.

2 Press **Search**.

Phone book
7 items
↓Add Search↓

3 Scroll to the desired item. To scroll down, press [▼]. To scroll up, press [▲].

0-9=Name search
▼▲=Scroll list

Phone book items are sorted in the following order:	
1	Alphabet letters (Alphabetical)
2	Space & ' () , - . /
3	Numbers 0 to 9
4	☐ *
5	Telephone numbers (If no name is stored)

4 Press [↶] or [☎].

- The displayed phone number is dialed.

Frank
444-5555
↓Erase Edit↓

- If “No items stored” is displayed in step 1, the phone book is empty.
- To exit the phone book, press **[OFF]**.
- To view a phone number over 16 digits long, repeat steps 1 to 3, then press **Edit** and then [▼]. When finished, press **[OFF]**.
- To quickly search the desired item, press [▼] or [▲] after step 1.

To search for a name by initial

1. Press **Phone book**.

2. Press **Search**.

3. Press the dialing button for the first letter of the desired name until any name with the same initial is displayed (see the Index on page 41).
Ex. To find “Frank”, press **[3]** repeatedly until the first item under “F” is displayed.

- If there are no items beginning with the character you selected, the first item in the next alphabetical index will be displayed.

4. Press [▼] repeatedly until the desired name is displayed.

Index table

Keys	Index	Keys	Index
[1]	Symbols, 1	[6]	M, N, O, 6
[2]	A, B, C, 2	[7]	P, Q, R, S, 7
[3]	D, E, F, 3	[8]	T, U, V, 8
[4]	G, H, I, 4	[9]	W, X, Y, Z, 9
[5]	J, K, L, 5	[0]	0, Space

Chain Dial **Handset**

You can dial a combination of phone book or manual key pad entries while making a call. This feature can be used, for example, to first automatically dial a calling card access number that you have stored in the phone book, then manually or automatically dial your PIN and then automatically dial the destination number from the phone book.

Ex. Using a long distance calling card

- To prevent misdialing, we recommend you add pauses where needed when storing numbers. For example, add pauses after a calling card access number and your PIN when storing in the phone book (p. 38).

1. Search and dial from phone book: 1-800-012-3456 (Calling card access number).
 - The voice guidance may be announced.
2. Search and dial from phone book: 1234 (Calling card PIN).
3. Search and dial from phone book: 1-555-012-3456 (Destination number).

1 While you are on a call;

Press **[MENU]**.

- 2** Press **[1]** to select "1=Phone book".

```
1=Phone book
2=Caller IQ
↓Back
```

- 3** Search for the desired item by pressing **[▼]** or **[▲]**.

- To search for an item by initial, see page 40.

```
Phone book
▼▲=Scroll list
↓Back Search↓
```

- 4** Press **Call**.

- The phone number is dialed.
- If required, repeat steps 1 to 4 for any remaining numbers.

```
Alan
1-555-012-3456
↓Back Call↓
```

- If you have rotary or pulse service, you need to press **[*]** before pressing **[MENU]** in step 1 to change the dialing mode temporarily to tone.

Phone Book

Editing an Item in the Phone Book **Handset**

1 Press **Phone book**.

2 Press **Search**.

3 Scroll to the desired item by pressing [**▼**] or [**▲**], then press **Edit**.

- To search for the item by initial, see page 40.

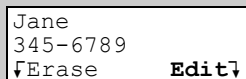

Jane
345-6789
↓Erase Edit↓

4 Edit the name (p. 39), then press [**▼**].

- If you do not need to change the name, press [**▼**] then go to step 5.

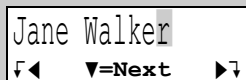

Jane Walker
← =Next →

5 Edit the phone number, then press [**▼**].

- If you do not need to change the number, press [**▼**] then go to step 6.
- Each time you press ←, a digit is erased. To erase all of the digits, press and hold ←.

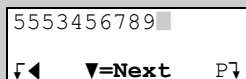

5553456789
← =Next P↓

6 Press **Save**.

- To continue editing other items, repeat from step 3.

7 Press [**OFF**].

Erasing an Item in the Phone Book **Handset**

1 Press **Phone book**.

2 Press **Search**.

3 Scroll to the desired item by pressing [**▼**] or [**▲**], then press **Erase**.

- To search for the item by initial, see page 40.

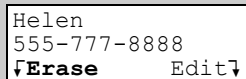

Helen
555-777-8888
↓Erase Edit↓

4 Press **Yes**.

- To erase other items, repeat from step 3.

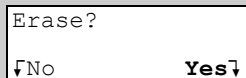

Erase?
↓No Yes↓

5 Press [**OFF**].

- To cancel erasing, press **No** after step 3.

Copying Items in the Phone Book **Handset**

You can copy one or all phone book items between two handsets. The destination handset will save the entries in its phone book.

- If an outside call is received during the phone book copy, copying will stop. You will need to re-send the item(s) later.
- After the copy has started, do not place your handset on the base unit or charger until copying finishes, otherwise copying will stop.

To copy one phone book item to another handset

Make sure the destination handset is not in use.

1 Press **[MENU]**.

2 Scroll to “Copy phone book” by pressing **[▼]** or **[▲]**, then press **Select**.



Copy phone book
 ⏪ Back ▼▲ Select ⏩

3 Press **select** at “Copy 1 item”.



Copy 1 item
 ⏪ Back ▼▲ Select ⏩

4 Scroll to the desired phone book item by pressing **[▼]** or **[▲]**, then press **Send**.

- To search for the item by initial, see page 40.
- You can continue by copying to other items.
- The destination handset displays “Phone book Receiving” then “Phone book Received”.

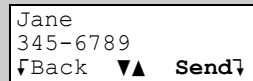

Jane
 345-6789
 ⏪ Back ▼▲ Send ⏩

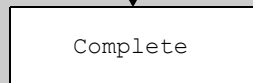

Complete

5 Press **[OFF]**.

Phone Book

To copy all of the items in your phone book to another handset

Make sure the destination handset is not in use.

1 Press **[MENU]**.

2 Scroll to “Copy phone book” by pressing **[▼]** or **[▲]**, then press **Select**.



Copy phone book
↓Back ▼▲ Select↓

3 Scroll to “Copy all items” by pressing **[▼]** or **[▲]**, then press **Select**.

- When all items have been copied, “Complete” is displayed.
- The destination handset displays “Phone book Receiving” then “Phone book Received”.



Copy all items
↓Back ▼▲ Select↓

Ex. Copying 1st item out of
10 items

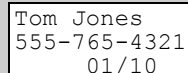

Tom Jones
555-765-4321
01/10

4 Press **[OFF]**.

- You can exit phone book copying mode by pressing **[OFF]**.

Intercom

Intercom calls can be made between the handset and the base unit, and between two handsets. You can page all handsets at once from the base unit, and announce the page to all handsets (**Voice Paging**, page 47).

The handsets have the extension number 1 and 2 which has “[1]” and “[2]” on the display.

- If the handset is off the base unit or charger when there are missed calls or new messages, the handset’s extension number “[1]” or “[2]” is not displayed. To confirm the extension number, either place the handset on the base unit or charger, or view the missed calls (p. 33) and listen to the new messages (p. 58).

Making Intercom Calls

From **Handset**

1 Press **[HOLD/INTERCOM]**.

- 2** To page the base unit, press **Base**.
To page another handset, press **Handset**.
- The paged unit will ring for 1 minute.
 - To stop paging, press **[OFF]**.

Select for
Intercom
↓Base Handset↓

Ex. Calling Base unit

Calling Base

Ex. Calling Handset 2

Calling HS[2]

- 3** When the paged party answers, start talking.
- You can switch to the speaker by pressing **[↔]**. To switch back to the receiver, press **[↶]**.

Intercom
00-00-05
Mute↓

4 To disconnect the intercom, press **[OFF]**.

From **Base Unit**

Using this feature, you can also locate a misplaced handset.

- 1** Press **[LOCATOR/INTERCOM]**.
- The SP-PHONE indicator lights.

- 2** To page all handsets, press **[0]**.
To page a specified handset, press its extension number **[1]** (**/**) or **[2]** (**/**).
- The handset will ring for 1 minute.
 - To stop paging, press **[SP-PHONE]** or **[LOCATOR/INTERCOM]**.

3 When the paged party answers, talk into the **MIC**.

- 4** To disconnect the intercom, press **[SP-PHONE]** or **[LOCATOR/INTERCOM]**.
- The indicator light goes out.

Intercom

During an intercom call:

- If you have difficulty hearing while using the handset speakerphone and base unit speaker, decrease the speaker volume by pressing **VOLUME [v]** on the base unit or **[v]** on the handset.
- If an incoming call is being received, you will hear two tones (incoming call tone, page 53) and “**LINE IN USE**” will flash rapidly on the base unit.
To answer the call;
 - if using the handset, press **[OFF]**, then **[↶]** or **[↷]**.
 - if using the base unit, press **[SP-PHONE]** twice.

Answering Intercom Calls

Handset

When a handset is paged, it rings and the Ringer/Message Alert indicator flashes rapidly. The display shows the calling extension.

1 Press **[↶]**, **[↷]** or **[HOLD/INTERCOM]**.

- You can also answer a call by pressing any button except **[v]**, **[▲]** or **[OFF]**.

Ex. Base calling

Call from Base

Ex. Handset 2 calling

Call from HS[2]

2 To disconnect the intercom, press **[OFF]**.

- If the Auto Talk feature is turned on (p. 16), you can also answer a page by simply lifting the handset off the base unit or charger.

Base Unit

When the base unit is being paged, it rings.

1 Press **[SP-PHONE]** or **[LOCATOR/INTERCOM]**.

2 To disconnect the intercom, press **[SP-PHONE]** or **[LOCATOR/INTERCOM]**.

- When the ringer volume is turned off (p. 17, 18), the handset and the base unit will ring at the low level for intercom calls.
- You cannot change the ringer tone for intercom calls.
- When the base unit user pages all handsets, only the handset user who answers first can talk with the base unit user.

Voice Paging **Base Unit**

The base unit user can make a voice announcement that is heard through the speakers of all handsets.

1 Press **[LOCATOR/INTERCOM]**.

- The SP-PHONE indicator lights.

2 To make a voice announcement to all handsets, press **[3]** (**PAGE**).

- You will hear a ringback tone (two short beeps) and the SP-PHONE indicator flashes.

3 When the SP-PHONE indicator stops flashing, speak into the **MIC**.

- All handset users will hear your voice through their speakers after beeps, and “Call from Base” will be displayed and the Ringer/Message Alert indicator will flash rapidly on the handsets.
- The handset on the base unit will not be paged.

4 When finished, press **[SP-PHONE]** or **[LOCATOR/INTERCOM]**. OR

When one of the handsets answers, talk into the **MIC**.

To disconnect the intercom, press **[SP-PHONE]** or **[LOCATOR/INTERCOM]**.

- Only the handset user who answers first can talk with the base unit user.
 - To answer the page from the handsets, see “Answering Intercom Calls” on page 46.
 - It is not possible to specify which handset will hear the voice announcement.
 - If a handset is too close to the base unit, you may hear feedback while making the voice announcement.
- Place the handset on the base unit or charger or press **[OFF]**.
- The announcement is heard at the handset ringer volume (p. 17).

Transferring a Call

You can transfer an outside call to the base unit or the handset.

From the **Handset** to the **Base Unit**

1 Handset:

(1) During a call, press **[HOLD/INTERCOM]**.

- The call is put on hold.

(2) Press **Base**.

(3) Wait for the paged party to answer, then you can announce the transfer.

- After the paged party answers, “Intercom hold” is displayed.
- If the paged party does not answer, press **[↶]** or **[↷]** to return to the outside call.

Line on hold.
Transfer to
↓**Base** Handset↓

Hold
Calling Base

2 Base unit:

Press **[SP-PHONE]** or **[LOCATOR/INTERCOM]** to answer the page.

3 Handset: To complete the transfer, press **[OFF]**.

From the **Base Unit** to the **Handset**

1 Base unit:

(1) During a call, press **[LOCATOR/INTERCOM]**.

- The call is put on hold.

(2) To page a specified handset, press its extension number **[1]** (**1**) or **[2]** (**2**).

To page all handsets, press **[0]**.

After the handset user answers, announce the transfer.

OR

To make a voice announcement to all handsets, press **[3]** (**PAGE**), then speak into the **MIC** when the SP-PHONE indicator stops flashing.

- If the paged party does not answer, press **[LOCATOR/INTERCOM]** to return to the outside call.

2 Handset:

Press **[↶]**, **[↷]** or **[HOLD/INTERCOM]** to answer the page.

- You can also answer a call by pressing any button except **[▼]**, **[▲]** or **[OFF]**.

3 Base unit: To complete the transfer, press **[SP-PHONE]**.

- When the base unit user calls all handsets, only the handset user who answers first can take the transferred call.

Transferring a Call

From a **Handset** to another **Handset**

- 1 During a call, press **[HOLD/INTERCOM]**, then page another handset by pressing **Handset**.
- 2 Wait for the paged party to answer, then you can announce the transfer.
 - After the paged party answers, “Intercom hold” is displayed.
 - The paged handset user can answer by pressing **[↶]**, **[⇐]** or **[HOLD/INTERCOM]**. (Any button except **[▼]**, **[▲]** or **[OFF]** can be pressed to answer the page.)
 - If the paged party does not answer, press **[↶]** or **[⇐]** to return to the outside call.
- 3 To complete the transfer, press **[OFF]**.
 - If the Auto Talk feature is turned on (p. 16), the paged handset user can also answer a page by simply lifting the handset off the base unit or the charger.
 - Any user can answer a transferred call by pressing **[↶]**, **[⇐]** or **[SP-PHONE]**.

Quick call transfer

You can transfer a call without waiting for the paged party to answer.

Handset

- 1 During a call, press **[HOLD/INTERCOM]**, then press **Base** or **Handset**.
- 2 Press **[OFF]** to hang up.

Base Unit

- 1 During a call, press **[LOCATOR/INTERCOM]**.
- 2 Press the extension number **[1]** (**/**) or **[2]** (**/**) or press **[0]** to page all handsets.
- 3 Press **[SP-PHONE]** to hang up.
 - The call will be transferred directly.
 - The paged party can answer the transferred call by pressing **[↶]**, **[⇐]** or **[SP-PHONE]**.
 - After the paged party answers, the transfer is complete.
 - If the paged party does not answer:
 - for the handset, press **[↶]** or **[⇐]** to return to the outside call.
 - for the base unit, press **[SP-PHONE]** to return to the outside call.
 - If the paged party does not answer within 60 seconds after you hang up, your phone will ring and the call will be returned to your phone. You may speak to the caller again by pressing **[↶]**, **[⇐]** or **[SP-PHONE]**.
If you do not answer the call within 4 minutes, the call will be disconnected.



Conference Calls

While you are talking with an outside caller, the base unit user or a handset user can join the conversation and establish a conference call.

Handset

- 1 During a call, press **[HOLD/INTERCOM]**.
 - The call is put on hold.
 - 2 To page the base unit, press **Base**.
To page another handset, press **Handset**.
 - 3 When the paged party answers, press **Conf** on your unit to make a conference call.
 - “Conference” is displayed during a conference call.
-

Base Unit

- 1 During a call, press **[LOCATOR/INTERCOM]**.
 - The call is put on hold.
 - 2 To page a handset, press the extension number **[1]** () or **[2]** ()
 - 3 When the paged party answers, press **[HOLD/CONF]** on your unit to make a conference call.
-

- To leave the conference, press **[OFF]** on the handset or press **[SP-PHONE]** on the base unit. The two other parties can continue the conversation.
- During a conference, the outside call can be placed on hold by pressing **[HOLD/INTERCOM]** on the handset or **[HOLD/CONF]** on the base unit. Internal communications are not suspended. Only the person who placed the call on hold can resume the full conference by pressing **Conf** on the handset or **[HOLD/CONF]** on the base unit.

Call Share

This feature allows the base unit or the handset to join an existing outside call.

To join a conversation (Call Share)

Handset

Press [] or [].

- “Conference” is displayed.

Base Unit

Press **[SP-PHONE]**.

Special Features

Temporary Tone Dialing

(For Rotary or Pulse Service Users) **Handset** **Base Unit**

Press **[*]** (TONE) before entering access numbers which require tone dialing.

- The dialing mode changes to tone. You can enter numbers to access an answering service, electronic banking service, etc. When you hang up, the dialing mode will return to pulse.

Muting Your Conversation

During a call, you can mute your phone so the other party cannot listen to you. When muting your conversation, you can hear the other party.

Handset Press **Mute**.

- “Mute” will flash.
- **To release the mute**, press **Mute** again.
- If you press **[↶]** or **[↷]** to switch between the receiver and speaker, the mute will be released.

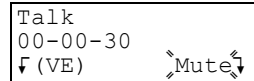

Talk
00-00-30
↓ (VE) Mute

Base Unit Press **[MUTE]**.

- The SP-PHONE indicator flashes.
- **To release the mute**, press **[MUTE]** again.

For Call Waiting Service Users

Handset **Base Unit**

Press **[FLASH/CALL WAIT]** if you hear a call waiting tone during a conversation.

- The first call is put on hold and you can answer the second call.
- To return to the first caller, press **[FLASH/CALL WAIT]** again.
- Call Waiting service cannot be used when the first call is put on hold, or the Answering System is handling a call.
- If this function does not operate properly, consult your telephone company for details.

Call Waiting Caller ID display **Handset**

If you subscribe to both Caller ID and Call Waiting with Caller ID services (CWID), when a second call is received while talking, the second caller's information will be displayed. After you hear a call waiting tone while talking, the display shows the caller's name with the phone number and “----Waiting----”.

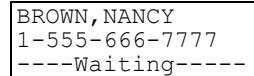

BROWN, NANCY
1-555-666-7777
----Waiting----

- Contact your telephone company for details about availability in your area, and to verify that CWID is activated on your telephone line.
- The caller's information will only be shown on the display of the handset which is on the outside call.
- The second caller's name will not be announced even if the Talking Caller ID feature is on (p. 31).

For assistance, please call: 1-800-211-PANA(7262)

Special Features

Using the PAUSE Key

(For PBX Line/Long Distance Calls) **Handset**

We recommend you press **Pause** or **P** if a pause is required for dial with a PBX or to make a long distance call.

Ex. Line access number **[9]** (PBX)

[9] ➔ **Pause** or **P** ➔

- Pressing **Pause** or **P** once creates a 3.5 second pause. This prevents misdialing when you dial after confirming the entered number (p. 26) or dial a stored number (p. 40, 41).
- Pressing **Pause** or **P** more than once increases the length of the pause between numbers.

Example

9P15556667777
↓Clear Pause↓

OR

9P15551234567
↓◀ ▼=Next P↓

FLASH Button **Handset** **Base Unit**

Pressing **[FLASH/CALL WAIT]** allows you to use special features of your host PBX such as transferring an extension call, or accessing optional telephone services such as call waiting.

- Pressing **[FLASH/CALL WAIT]** cancels Temporary Tone Dialing mode or the mute (p. 51).

Selecting the flash time **Handset**

The flash time required depends on your telephone exchange or host PBX. You can select the following flash times: “700, 600, 400, 300, 250, 110, 100 or 90 ms (milliseconds)”. The factory preset is “700 ms”.

- If PBX functions do not work correctly, consult your PBX supplier for the correct settings.

1 Press **[MENU]**.

2 Scroll to “Initial setting” by pressing **[▼]** or **[▲]**, then press **Select**.

Initial setting
↓Back ▼▲ Select↓

3 Scroll to “Set tel line” by pressing **[▼]** or **[▲]**, then press **Select**.

Set tel line
↓Back ▼▲ Select↓

4 Scroll to “” by pressing **[▼]** or **[▲]**, then press **Select**.

Set flash time
↓Back ▼▲ Select↓

5 Select the desired time by pressing **[▼]** or **[▲]**.

Set flash time
:700ms
↓Back ▼▲ Save↓

6 Press **Save**, then press **[OFF]**.

Incoming Call Tone **Handset** **Base Unit**

During an intercom call (p. 45), you can be informed of incoming calls by two tones. If this feature is turned on, incoming call tones will be heard for as long as the line is ringing. If this feature is set to “2”, incoming call tones will be heard only 2 times. If this feature is turned off, no tones will be heard. The factory preset is “2”. Using the handset, this feature can be set separately for the handset and base unit.

Handset incoming call tone **Handset**

1 Press **[MENU]**.

2 Scroll to “Ringer setting” by pressing **[▼]** or **[▲]**, then press **Select**.

Ringer setting
 ↓Back ▼▲ Select↓

3 Scroll to “Incoming call.” by pressing **[▼]** or **[▲]**, then press **Select**.

Incoming call.
 ↓Back ▼▲ Select↓

4 Select “On”, “Off” or “2” by pressing **[▼]** or **[▲]**.

Incoming call
 tone :2
 ↓Back ▼▲ Save↓

5 Press **save**, then press **[OFF]**.

Base unit incoming call tone **Handset**

1 Press **[MENU]**.

2 Scroll to “Initial setting” by pressing **[▼]** or **[▲]**, then press **Select**.

Initial setting
 ↓Back ▼▲ Select↓

3 Scroll to “Set base unit” by pressing **[▼]** or **[▲]**, then press **Select**.

Set base unit
 ↓Back ▼▲ Select↓

4 Scroll to “Incoming call.” by pressing **[▼]** or **[▲]**, then press **Select**.

Incoming call.
 ↓Back ▼▲ Select↓

5 Select “On”, “Off” or “2” by pressing **[▼]** or **[▲]**.

Incoming call
 tone :2
 ↓Back ▼▲ Save↓

6 Press **save**, then press **[OFF]**.

Special Features

Key Tone **Handset**

You can select whether or not the handset keys will sound tones (key tone, confirmation tone, error tone). The factory preset is ON.

1 Press **[MENU]**.

2 Scroll to “Initial setting” by pressing **[▼]** or **[▲]**, then press **Select**.

3 Scroll to “Key tone” by pressing **[▼]** or **[▲]**, then press **Select**.



Key tone
↓Back ▲ Select↓

4 Select “Off” or “On” by pressing **[▼]** or **[▲]**.



Key tone
:On
↓Back ▲ Save↓

5 Press **save**, then press **[OFF]**.

Re-registering the Handset **Handset & Base Unit**

If “No link to base. Move closer to base, try again.” is displayed even when using the handset near the base unit, the handset may have lost communication with the base unit. You need to re-register the handset to the base unit.

- **Make sure the base unit is not being used.**
- **Have both handsets and base unit nearby during registration.**
- **Follow steps 1–3 listed below. You have about 1 minute to complete them.**
- **Confirm the extension number of the handset which has lost the communication by placing the handset on the base unit or charger.**

If you re-register the handset using the other handset’s extension number, the other handset will not function.

1 **Base unit:** Press and hold **[LOCATOR/INTERCOM]** until a beep sounds.

- The CHARGE indicator flashes.

2 **Base unit:** Press the extension number **[1]** (*/*) or **[2]** (*/*) of the handset which has lost the communication.

3 **Handset:** Press and hold **[FLASH/CALL WAIT]** until “Handset Registering” is displayed.

- When registration is complete, a beep sounds from the handset and the display shows the number.
- **Wait for 20 seconds after registration is complete while the handset establishes communication with the base unit.**

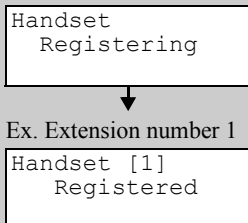

Handset Registering
↓
Ex. Extension number 1
Handset [1] Registered

- If the handset beeps 3 times and “Error!!” is displayed, an error occurred. Try again from step 1.
- You can stop registration by pressing **[OFF]** on the handset, and pressing **[LOCATOR/INTERCOM]** on the base unit.

Automatic Answering Operation

When the unit answers a call, a greeting message is played and the caller's message is recorded.

- The total recording time of all messages (greeting, incoming and memo) is **about 16 minutes**. If messages are recorded in noisy rooms, the time may be shortened by up to 3 minutes.
- To select the caller's recording time, see page 22.
- A maximum of 64 messages (including greeting and memo message) can be recorded.

Setting the Unit to Answer Calls **Base Unit**

Press **[ANSWER ON]** to turn on the Answering System.

- The indicator lights and the unit announces "Answer set" and current day and time. If "Answer set. Set time" is heard, set the date and time (p. 14).
- The unit will announce the remaining recording time if it is less than 3 minutes.
- When no recording time is available, you will need to erase any unnecessary messages before new messages can be recorded (p. 60). The unit can indicate that memory is full in the following ways:
 - "**FULL**" will flash on the base unit and the ANSWER ON indicator will flash rapidly until you erase a message.
 - The unit will announce "Memory full" when you press **[ANSWER ON]**, **[GREETING REC]**, or **[MEMO]**, and after playing back messages or recording a message.
- If you do not want the unit to answer calls, press **[ANSWER ON]** again to turn off the Answering System. The indicator light goes out and "Answer off" is heard.
- You can also turn on the Answering System remotely from an outside phone (p. 65).
- If you subscribe to Caller ID (p. 30), Caller ID information automatically adjusts the date and time when a call is received, provided you have already set the date and time manually (p. 14).



[ANSWER ON] and Indicator

Handset

- 1 Press **[MENU]**.
- 2 Press **select** at "Message play".
- 3 Press **[8]** to turn on the Answering System.
 - "Answer set" is heard.
- 4 Press **[OFF]**.

- To turn the Answering System off, press **[0]** in step 3. "Answer off" is heard.

Automatic Answering Operation

Monitoring Incoming Calls **Base Unit**

While a caller is leaving a message, you can monitor the call through the base unit speaker.

- To increase the speaker volume while monitoring, press **VOLUME [^]**. To decrease the volume, press **VOLUME [v]**.

To answer a call while monitoring, press **[SP-PHONE]** on the base unit or press **[↶]** or **[↷]** on the handset.

To turn the incoming call monitoring feature off

When the base unit is not in use, press **[GREETING CHECK]**, then press **VOLUME [v]** repeatedly until “0” is displayed. (Make sure the Answering System is turned on.)

OR

While monitoring, press **VOLUME [v]** repeatedly until “0” is displayed.

- If the incoming call monitoring feature is turned off, it will remain off when the next call is monitored.
- If you adjust the speaker volume while playing back messages or using the speakerphone, the speaker volume for monitoring will be turned on again. To turn the speaker volume off, see “To turn the incoming call monitoring feature off” of above step.

Listening to Messages

Voice Day/Time Stamp: During playback, the unit will announce the day and time when each message was recorded (p. 14).

Using the Base Unit **Base Unit**

You can see the total number of recorded messages on the base unit display. If the NEW MESSAGE indicator flashes on the base unit, new messages have been recorded.

To play back messages

Press **[MESSAGE]**.

- The unit announces the number of new messages and only new messages are played back.
- When you have no new messages, the unit announces “No new messages. All message playback” and plays back all messages.
- When you have no messages, the unit announces “No messages”.

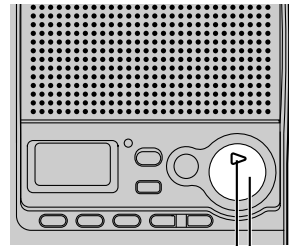

NEW MESSAGE Indicator

[MESSAGE]

- During playback, the display shows the message number.
- At the end of the last message, “End of final message” is heard. The unit will announce the remaining recording time if it is less than 3 minutes.
- If a call is received during playback, the unit rings and playback stops. To answer the call, press **[SP-PHONE]**. For playback, start again from the beginning after hanging up.

Listening to Messages

Using the Handset (Remote Operation) **Handset**

If "New message" is displayed on the handset, new messages have been recorded.

- If the Message Alert is turned on (p. 24), the Ringer/Message Alert indicator on the handset will flash slowly when new messages have been recorded and the handset is not in use.

To play back messages

1 Press **[MENU]**.

2 Press **select** at "Message play".

- The unit announces the number of new messages and only new messages are played back from the speaker. To switch to the receiver, press **[↶]**. To switch back to the speaker, press **[↷]**.
- When you have no new messages, the unit announces "No new messages. All message playback" and plays back all messages.
- When you have no messages, the unit announces "No messages".
- To play all messages, press **[5]**.
- If you do not press any button, the voice menu will start (see below).



Message play
↶Back ▼▲ Select↷

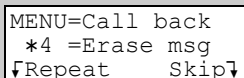

MENU=Call back
*4 =Erase msg
↶Repeat Skip↷

3 To end remote operation, press **[OFF]**.

- If a call is received during playback, the unit rings and playback stops. To answer the call, press **[↶]** or **[↷]**. For playback, start again from the beginning after hanging up.
- At the end of the last message, "End of final message" is heard. The unit will announce the remaining recording time if it is less than 3 minutes.
- If you hear "Memory full" after playback, erase unnecessary messages (p. 60).
- When memo messages are played (p. 61), "MEMO" is displayed.

Voice menu

If you do not press any buttons at the end of the last message, the unit will announce "End of final message" and the voice menu will begin.

The unit announces, "Press 4 to play back new messages. Press 5 to play back all messages."

- You can press buttons for other playback options (p. 59) even if the voice menu has started.
- If you do not press any button within 10 seconds after the voice menu, the handset will exit remote operation.

Listening to Messages



For Caller ID service users (p. 30)

During playback using the handset, the handset display will show the name and/or number of the caller whose message is being played.

To call back the displayed number:

1. During playback, press **[MENU]**.

```
Helen
1-555-777-8888
↓Repeat      Skip↓
```

2. Press **Call**, [] or [].

```
Helen
1-555-777-8888
↓Edit        Call↓
```

- The unit stops playback and dials the phone number.
- If you need to edit the phone number to call back, see page 34.

During playback **Base Unit** **Handset**

To adjust the speaker volume	<p><i>Base unit:</i> To increase volume, press VOLUME [^]. To decrease volume, press VOLUME [v].</p> <p><i>Handset:</i> To increase volume, press [▲]. To decrease volume, press [▼].</p> <ul style="list-style-type: none"> • You can also adjust the receiver volume on the handset.
To repeat a message	<p><i>Base unit:</i> Press [REPEAT].</p> <p><i>Handset:</i> Press Repeat or [1].</p> <ul style="list-style-type: none"> • If pressed within the first 5 seconds of playback, the previous message will be played.
To skip a message	<p><i>Base unit:</i> Press [SKIP].</p> <p><i>Handset:</i> Press skip or [2].</p>
To stop playback	<p><i>Base unit:</i> Press [STOP].</p> <ul style="list-style-type: none"> • To resume playback, press [MESSAGE]. • If you do not press any button for 60 seconds or if you press [STOP] again, playback mode will be canceled. <p><i>Handset:</i> Press [9].</p> <ul style="list-style-type: none"> • If you do not press any button within 15 seconds after stopping playback, the voice menu will start (p. 58).

Erasing Messages

The unit will announce the remaining recording time after playback if it is less than 3 minutes.

New messages cannot be recorded when:

- “Memory full” is heard.
- “**FULL**” flashes on the base unit.
- the ANSWER ON indicator flashes rapidly (when the Answering System is on).

Erase unnecessary messages. We recommend you erase unnecessary messages after each playback.

Erasing a specific message

Base Unit

Press **[ERASE]** while the message you want to erase is being played.

- The unit beeps, then plays back the next message.
- To exit playback mode, press **[STOP]** twice.

Handset

Press **[*] [4]** while the message you want to erase is being played.

- The unit beeps, then plays back the next message.
- To exit remote operation mode, press **[OFF]**.

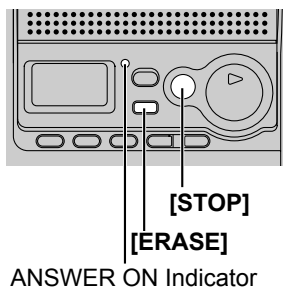

Erasing all messages

All recorded messages, except the greeting message, can be erased at one time.

Base Unit

1 Press **[ERASE]** while the base unit is not being used.

- “To erase all messages, press ERASE again” is heard.

2 Within 10 seconds, press **[ERASE]** again.

- The unit beeps, then announces “No messages”.
- The base unit display shows “0”.

Handset

1 Press **[MENU]**.

2 Press **select** at “Message play”.

3 Press **[*] [5]**.

- The unit beeps, then announces “No messages”.
- To end remote operation, press **[OFF]**.

- Information in the Caller List will not be erased. To erase caller information, see page 37.

Recording a Memo Message

Base Unit

You can record a voice memo message of up to 3 minutes in memory.

- 1** Press **[MEMO]**.
- 2** After the long beep, talk clearly 20 cm (8 inches) away from the **MIC**.
 - The base unit display shows the elapsed recording time.
 - If the elapsed recording time exceeds 99 seconds, the counter continues from 00 to indicate 100 seconds.
- 3** When finished, press **[MEMO]** or **[STOP]**.
 - The NEW MESSAGE indicator flashes.

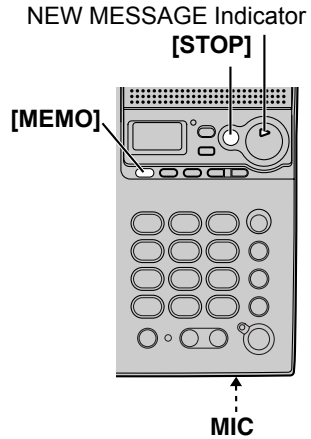

- If you record for over 3 minutes in step 2, the unit will stop recording.
- If "E" is displayed, 6 beeps sound and "Your message was not recorded. Record your message again." is announced, start again from step 1.

Remote Operation from a Touch Tone Phone

While outside, you can operate the Answering System from any touch tone phone. A synthesized voice menu will guide you through the Answering System (p. 64).

- To skip the voice menu and operate the unit directly, see page 65.

Summary of remote operation

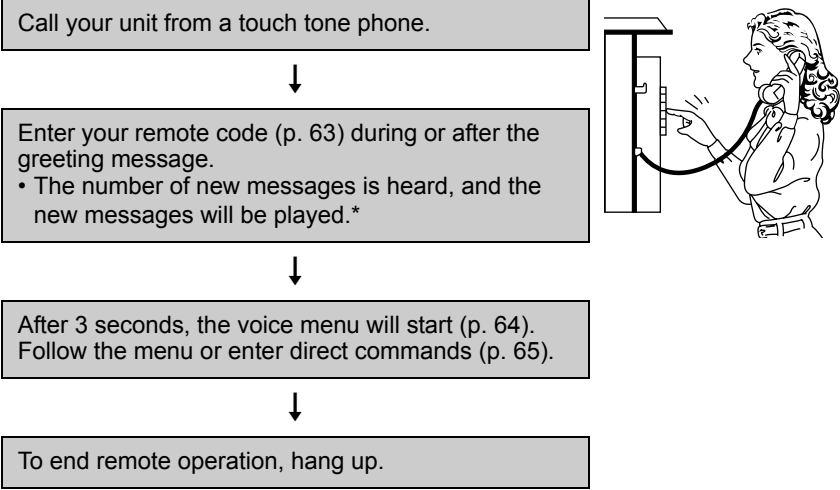

- The unit will announce the remaining recording time after playback if it is less than 3 minutes.
- The messages are saved.
- * If “No new messages” is announced, the unit has only old messages.
If “No messages” is announced, the unit has no messages.

Remote Operation from a Touch Tone Phone

Remote Code **Handset**

The remote code prevents unauthorized people from accessing your unit and listening to your messages. Choose any **2-digit number (00–99)** for your remote code. The factory preset remote code is “11”. If you do not program your own remote code, you can use “11”.

1 Press **[MENU]**.

2 Scroll to “Initial setting” by pressing **[▼]** or **[▲]**, then press **Select**.

Initial setting
↓Back ▼▲ Select↓

3 Press **select** at “Set answering”.

Set answering
↓Back ▼▲ Select↓

4 Scroll to “Remote code” by pressing **[▼]** or **[▲]**, then press **Select**.

Remote code
↓Back ▼▲ Select↓

5 Enter a **2-digit remote code (00–99)**.

Remote code
:11
↓Back Save↓

6 Press **save**, then press **[OFF]**.

To confirm the remote code, repeat steps 1 to 4.

- The remote code is displayed. When finished, press **[OFF]**.

Remote Operation from a Touch Tone Phone

Voice Menu

The shaded parts are voice prompts.

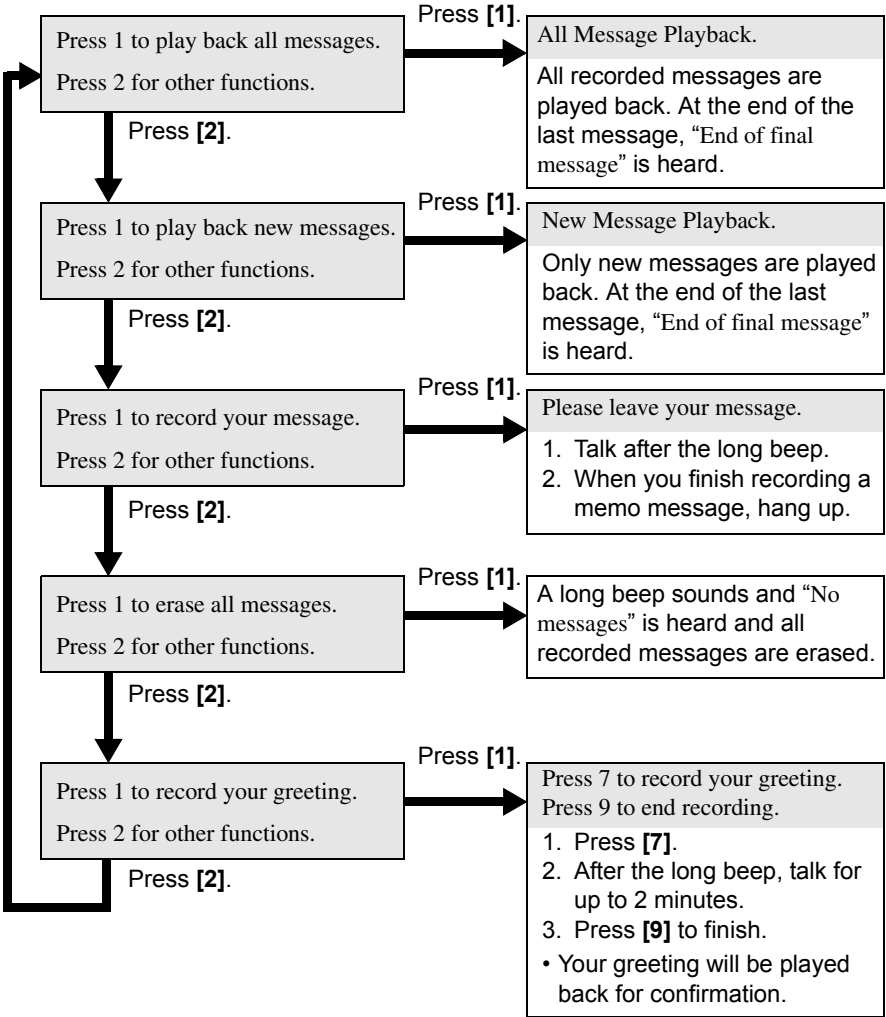

- 3 seconds after playback, the voice menu will start again from the beginning.
- The unit will announce the remaining recording time after playback if it is less than 3 minutes.
- If you hear "Memory full" after playback, erase unnecessary messages (p. 65).
- If you do not press any buttons within 10 seconds after a voice prompt, "Thank you for your call." will be heard and the call will be disconnected.

Remote Operation from a Touch Tone Phone

Direct Remote Operation

Once you have entered the remote code, you can also control your unit by direct commands instead of using the voice menu. To end remote operation, hang up at anytime.

Direct commands

[4] :	Plays back new messages.	[7] :	Records a greeting message. After the long beep, talk for up to 2 minutes.
[5] :	Plays back all messages.		
[1] :	Repeats the current message. <ul style="list-style-type: none">• If pressed within the first 5 seconds of playback, the previous message will be played.	[9]	Recording is stopped. <ul style="list-style-type: none">• The greeting is played.
[2] :	Skips the current message.	[*] [4] :	Erases the current message. <ul style="list-style-type: none">• A short beep will sound and the next message will be played.
[9] :	Stops the current operation. <ul style="list-style-type: none">• To resume, enter a direct command within 15 seconds, or the voice menu will start (p. 64).	[*] [5] :	Erases all messages. <ul style="list-style-type: none">• A long beep will sound and "No messages" will be heard.
		[0] :	Turns off the Answering System. <ul style="list-style-type: none">• The unit hangs up.

To turn on the Answering System:

Call your unit and wait for 15 rings.

- The unit will answer and the greeting will be played.
- The Answering System will be turned on. Hang up or enter the remote code for other options.
- When turning on the Answering System using a rotary or pulse service telephone, you cannot enter the remote code for other options.

Skipping the greeting

After calling your unit, press **[*]** during the greeting.

- The unit skips the rest of the greeting and you can start recording your message after the long beep.

Belt Clip

You can hang the handset on your belt or pocket using the included belt clip.

To attach the belt clip

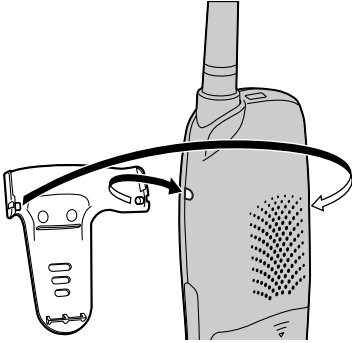

To remove the belt clip

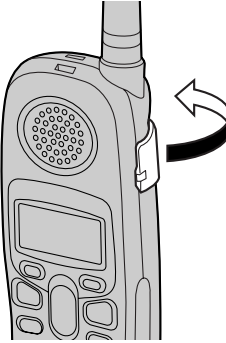

Optional Headset

Connecting an optional headset to the handset allows hands-free phone conversation. Please use only a Panasonic KX-TCA60, KX-TCA86, KX-TCA88, KX-TCA88HA, KX-TCA91, KX-TCA92, or KX-TCA98 headset. To order, call the accessories telephone number on page 2.

Connecting an optional headset

Open the headset jack cover, and insert the headset plug into the headset jack as shown below.

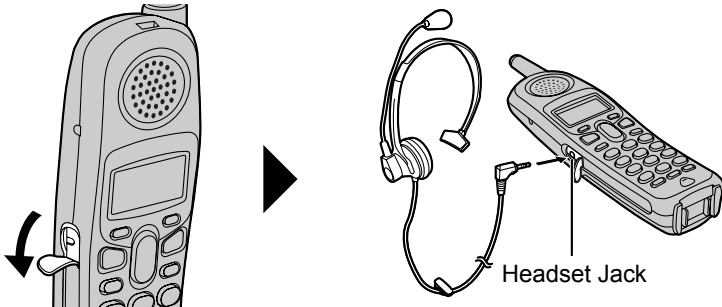

- Headset sold separately. Model shown here is KX-TCA88.

To switch to the speakerphone while using the headset:

Press [↵]. To return to the headset, press [↶].

Wall Mounting

This unit can be mounted on a wall phone plate.

Base unit

- 1 Push the hook and turn it upward. Turn the hook until a click is heard.

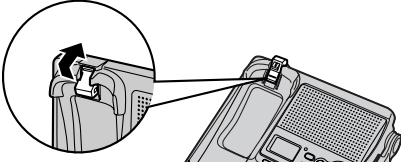

- 2 Press the tabs in the direction of the arrows (1), then remove the wall mounting adaptor (2).

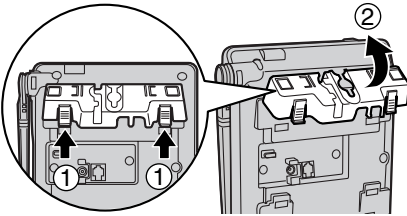

- 3 Connect the AC adaptor. Tuck the telephone line cord inside the wall mounting adaptor, then push the adaptor in the direction of the arrows (1 and 2).

- The word "UP WALL" should face upward.
- Fasten the AC adaptor cord to prevent it from being disconnected.

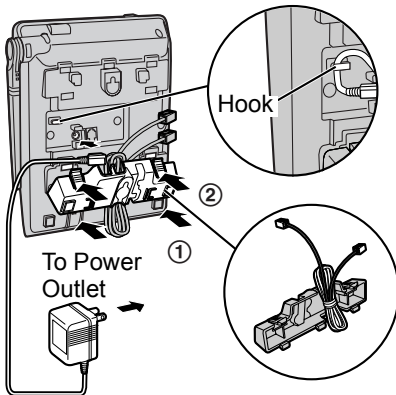

- 4 Connect the telephone line cord. Mount the unit, then slide it down.

- Raise the antenna.

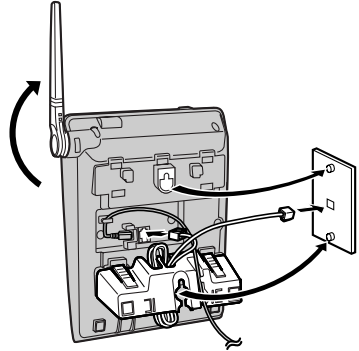

- 5 To charge the handset battery:

Rest the handset on the charge contacts (1), then push the top of the handset so the hook snaps into the slot at the top of the handset (2).

- The unit beeps once and the CHARGE indicator lights.

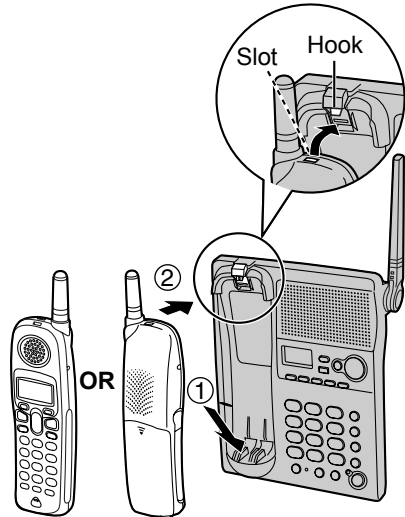

Wall Mounting

Charger unit

The charger can be wall mounted. Connect the AC adaptor. Install screws using the wall template (see below). Mount the charger (①). Slide it down (②), then slide it down to the right (③) until it is secured.

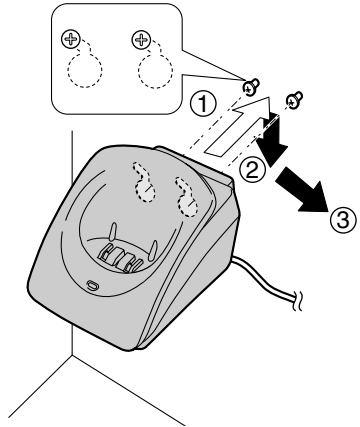
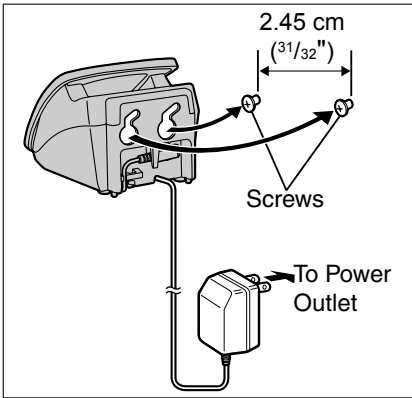

Wall Template for the Charger unit

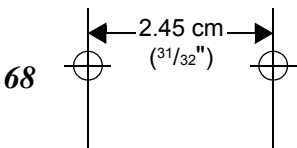

Direct Commands

Handset

After pressing **[MENU]**, you can also program menu items directly by pressing **[0]** to **[9]**, **[*]** and **[#]** instead of using the soft keys.

Menu item	Command	Selection items	Page
Ringer volume	[1] [1]	[0] : Off [1] : Low [2] : Medium [3] : High	p. 17
Ringer tone (for handset)	[1] [2]	[1]–[3] : Tone pattern 1–3 [4]–[7] : Melody pattern 1–4 [8]–[9] : Downloaded melody pattern 1–2 *1	p. 18
Incoming call tone (for handset)	[1] [3]	[1] : On [2] : Twice [0] : Off	p. 53
Message play	[2]		p. 58
Date and time	[4]	Go to Step 3 on page 14.	—
Voice enhancer	[5]	[1] : On [0] : Off	p. 27
Activate Caller IQ *2	[7] [1]		—
View information *4	[7] [2] *5	Go to Step 4 on page 81.	—
Get new information *3	[7] [3] *5	Go to Step 4 on page 80.	—
Turn Caller IQ off *3	[7] [4] *5		p. 78
Turn Caller IQ on *3	[7] [5] *5		p. 78
Talking Caller ID (for handset)	[9]	[1] : On [0] : Off	p. 31
Copy phone book –Copy 1 item	[#] [1]	Go to Step 4 on page 43.	—
Copy phone book –Copy all items	[#] [2]		p. 44
LCD contrast	[0] [1]	[1]–[6] : Level 1–6	p. 20
Key tone	[0] [2]	[1] : On [0] : Off	p. 54
Auto talk	[0] [3]	[1] : On [0] : Off	p. 16
Caller ID number auto edit	[0] [4]	[1] : On [0] : Off	p. 35
Set dial mode	[0] [5] [1]	[1] : Pulse [2] : Tone	p. 15

Direct Commands

Menu item	Command	Selection items	Page
Set flash time	[0] [5] [2]	[1] : 700 ms [2] : 600 ms [3] : 400 ms [4] : 300 ms [5] : 250 ms [6] : 110 ms [7] : 100 ms [8] : 90 ms	p. 52
Set line mode	[0] [5] [3]	[1] : A [2] : B	p. 16
Number of rings	[0] [6] [1]	[2]–[7] : 2–7 rings [0] : Toll saver	p. 23
Recording time	[0] [6] [2]	[1] : 1 minute [2] : 2 minutes [3] : 3 minutes [0] : Greeting only	p. 22
Remote code	[0] [6] [3]	Go to Step 5 on page 63.	—
Recording mode	[0] [6] [4]	[1] : Standard recording [2] : Enhanced recording	p. 24
Change language	[0] [8]	[1] : English [2] : Spanish	p. 15
Message alert	[0] [†]	[1] : On [0] : Off	p. 24
Ringer tone (for base unit)	[0] [✖] [1]	[1]–[3] : Tone pattern 1-3 [4]–[7] : Melody pattern 1-4 [8]–[9] : Downloaded melody pattern 1-2 *1	p. 19
Incoming call tone (for base unit)	[0] [✖] [2]	[1] : On [2] : Twice [0] : Off	p. 53
Talking Caller ID (for base unit)	[0] [✖] [4]	[1] : On [0] : Off	p. 32

During programming:

When “Save” is displayed, press the right soft key to save the new settings.

To exit programming, press [OFF].

- If you press the direct command incorrectly, press [OFF], then re-enter programming mode by pressing [MENU].
- For function details, see the corresponding pages.

*1 You need to first download melody data from the openLCR web site.

*2 Can be used to activate Caller IQ. See the leaflet included with this unit for more information.

*3 For openLCR subscribers only.

*4 For openLCR subscribers only. If information is not downloaded to your unit, “Get new Info.?” will be displayed. To download information, see page 80.

*5 After pressing [7], make sure “View Info.?” is displayed, then press the next command.

If Caller IQ is turned off, “Turn CIQ on?” is displayed after pressing [7].

If the Following Appear on Your Display...

The following will be displayed when the unit needs your attention.

Display message	Cause & Remedy
Recharge battery	<ul style="list-style-type: none"> The battery needs to be charged. Recharge the battery (p. 10).
Charge for 6h	<ul style="list-style-type: none"> The battery has been discharged. The handset will not work. Fully charge the battery (p. 10).
No link to base. Move closer to base, try again.	<ul style="list-style-type: none"> The handset has lost communication with the base unit. Walk closer to the base unit and try again or re-register the handset (p. 54). Confirm the base unit's AC adaptor is plugged in. Raise the base unit antenna.
Please lift up and try again.	<ul style="list-style-type: none"> A handset button was pressed while the handset was on the base unit or charger. Lift the handset and press the button again.
Busy	<ul style="list-style-type: none"> The base unit and/or another handset is in use. Try again later. The handset you tried to send phone book items to is in use. Try again later. The handset you are calling is too far from the base unit. Another handset is in programming mode. Try again later.
Error!!	<ul style="list-style-type: none"> When you tried to re-register the handset, the handset and base unit could not link for some reason, such as interference from electrical appliances. Move the handset and base unit away from any electrical appliances and try again. Another handset tried to send phone book items to you but the copying stopped (p. 43, 44).
Phone book full	<ul style="list-style-type: none"> When you tried to store an item in the phone book, the phone book memory was full. Press [OFF] to exit the programming mode. To erase other items from the phone book, see page 42.
System is busy. Please try again later.	<ul style="list-style-type: none"> The handset has lost communication with the base unit. Walk closer to the base unit and try again. The Answering System is in use, such as answering a call or playing back messages. Try again later. Another handset is in programming mode. Try again later.

If the Following Appear on Your Display...

Display message	Cause & Remedy
<p>---Incomplete--- Phone book full</p>	<ul style="list-style-type: none"> When phone book item(s) was(were) sent to another handset, the phone book memory was full and copying stopped. Press [OFF] to exit (p. 43, 44). To erase items from another handset phone book, see page 42. You can copy all of the items again or copy the items which have not been copied one by one (p. 43, 44).
<p>Example Tom Jones 555-765-4321</p>	<ul style="list-style-type: none"> When you tried to send phone book items, the other handset lost communication with the base unit, or the other handset made an outside call by pressing [↶] or [☎]. The handset displays the phone book item which was not copied to the other handset. Press [OFF], then try again (p. 43, 44).
<p>No items stored</p>	<ul style="list-style-type: none"> Your phone book is empty. No items were copied to another handset.
<p>Line in use</p>	<ul style="list-style-type: none"> The base unit or another handset is conducting an outside call or a parallel connected telephone is in use.
<p>Line on hold</p>	<ul style="list-style-type: none"> The base unit or another handset is on hold for an outside call.



Troubleshooting

If the handset display shows error messages, see “If the Following Appear on Your Display...” (p. 71–72) for the Cause & Remedy.

Telephone System

Problem	Cause & Remedy
<p>“No link to base. Move closer to base, try again.” is displayed and an alarm tone sounds.</p>	<ul style="list-style-type: none"> • You are too far from the base unit. Walk closer to the base unit. • Confirm the base unit’s AC adaptor is plugged in. • Raise the base unit antenna. • If the above remedies do not solve the problem, the handset may have lost communication with the base unit. Register the handset again (p. 54).
<p>Static, sound cuts in/out, fades. Interference from other electrical units.</p>	<ul style="list-style-type: none"> • Move the handset and base unit away from other electrical appliances (p. 3). • Walk closer to the base unit. • Raise the base unit antenna.
<p>The handset and/or base unit does not ring.</p>	<ul style="list-style-type: none"> • The ringer volume is turned off. Set to high, medium or, low (p. 17, 18).
<p>The handset display is blank.</p>	<ul style="list-style-type: none"> • If the only handset display is blank, fully charge the battery (p. 10).
<p>You cannot program any function items.</p>	<ul style="list-style-type: none"> • Programming is not possible while the handset and/or base unit is being used. • Do not pause for over 60 seconds while programming. • Walk closer to the base unit. • While another user is listening to messages or the Answering System is handling a call, you cannot program. Try again later.
<p>While programming or searching, the handset starts to ring and the program/search stops.</p>	<ul style="list-style-type: none"> • A call is coming in. To answer the call, press [↶], [↷] or [SP-PHONE]. Start again from the beginning after hanging up.
<p>You cannot make an intercom/outside call.</p>	<ul style="list-style-type: none"> • Your handset is in remote operation mode (p. 58). Exit by pressing [OFF]. • The handset you called is too far from the base unit. • If the handset or base unit is in use, you may not be able to make a call. Try again later.
<p>You cannot redial.</p>	<ul style="list-style-type: none"> • If the last number dialed was more than 48 digits long, the number will not be redialed correctly.

Troubleshooting

Problem	Cause & Remedy
You cannot make long distance calls.	<ul style="list-style-type: none"> • Please make sure you have long distance service. • Check if Caller IQ is on. Turn Caller IQ off (p. 78).
The handset does not display the caller's name and/or phone number.	<ul style="list-style-type: none"> • You need to subscribe to Caller ID. • Other telephone equipment may be interfering with your phone. Disconnect it and try again. • Other electrical appliances connected to the same outlet may be interfering with Caller ID. • Telephone line noise may be affecting Caller ID. • The caller requested not to send his/her Caller ID information (p. 30). • If a call is being transferred to you, the Caller ID information will not be displayed. • If a (separate) Caller ID box is connected between the unit and the telephone wall jack, disconnect the Caller ID box or plug the unit directly into the wall jack.
The handset and/or base unit does not announce the displayed caller's name.	<ul style="list-style-type: none"> • The handset and/or base unit ringer volumes are turned off. Set to high, medium, or low (p. 17, 18). • The Talking Caller ID feature is turned off (p. 31, 32). Turn it on.
The handset and/or base unit does not announce the displayed caller's name properly.	<ul style="list-style-type: none"> • Name pronunciation may vary. Name pronunciation quality is based on names most commonly used in the United States. • The handset and/or base unit will announce each letter of abbreviations, such as "Co." and "Inc." • Caller ID supports names of up to 15 letters. If the caller's name has more than 15 letters, the name will not be announced correctly.
The handset cannot automatically edit the Caller List/incoming phone numbers.	<ul style="list-style-type: none"> • The Caller ID number auto edit feature is turned off. Turn it on (p. 35) and try again. • You need to press  or  after editing the number.
The handset display exits the Caller List or phone book.	<ul style="list-style-type: none"> • Do not pause for over 60 seconds while searching.
The Ringer/Message Alert indicator flashes slowly when the handset is not ringing and in use.	<ul style="list-style-type: none"> • The Message Alert is turned on and new messages have been recorded. Turn the Message Alert off (p. 24) or listen to the new messages (p. 57, 58, 62).

Troubleshooting

Problem	Cause & Remedy
You cannot have a conversation using the headset.	<ul style="list-style-type: none">• Make sure the optional headset is connected properly (p. 66).• If “SP-phone” is displayed on the handset, press [] to switch to the headset.

Answering System

Problem	Cause & Remedy
The Answering System is on, but incoming messages are not recorded.	<ul style="list-style-type: none">• The recording time is set to “Greeting only”. Select “1 minute”, “2 minutes” or “3 minutes” (p. 22).• Memory is full. Erase unnecessary messages (p. 60).
“ FULL ” flashes and the ANSWER ON indicator flashes rapidly. No new messages are recorded.	<ul style="list-style-type: none">• Memory is full. Erase unnecessary messages (p. 60).
You cannot operate the Answering System from the base unit or the handset.	<ul style="list-style-type: none">• If another user is in use, you may not be able to operate the Answering System. Try again later.• If another user is listening to messages or the Answering System is handling a call, you cannot operate the Answering System. Try again later.
You cannot operate the Answering System from a touch tone phone.	<ul style="list-style-type: none">• Make sure you entered the correct remote code (p. 63).• The Answering System may not respond if the tones are too short to activate the unit. Press each button firmly.• The Answering System is off. Turn it on (p. 65).
You cannot erase messages.	<ul style="list-style-type: none">• While another user is operating the Answering System or a caller is leaving a message, you cannot erase messages.
When you play back messages or turn on the Answering System, the handset and/or base unit announces the wrong day and time.	<ul style="list-style-type: none">• The date and time may be set incorrectly. Set the date and time again (p. 14).

Troubleshooting

General

Problem	Cause & Remedy
The handset and/or base unit does not work.	<ul style="list-style-type: none">• Check the settings (p. 9–11).• Check whether the dialing mode setting is correct (p. 15).• Fully charge the battery (p. 10).• Clean the charge contacts and charge again (p. 11).• Check battery installation (p. 10).• Unplug the base unit's AC adaptor to reset it. Plug in, and try again.• Re-install the battery (p. 10) and fully charge it.
"Recharge battery" is displayed, "⏻" flashes, or the handset beeps intermittently.	<ul style="list-style-type: none">• Fully charge the battery (p. 10).
"Charge for 6h" and "⏻" are displayed and the handset does not work.	<ul style="list-style-type: none">• The battery has been discharged. Fully charge the battery (p. 10).• Check battery installation (p. 10).
You charged the battery fully, but "Recharge battery" is still displayed and/or "⏻" continues to flash, or "Charge for 6h" and "⏻" are displayed.	<ul style="list-style-type: none">• Clean the charge contacts and charge again (p. 11).• The battery may need to be replaced. If you install a new battery, fully charge it (p. 10).
The CHARGE indicator does not go out after the battery has been charged.	<ul style="list-style-type: none">• This is normal.
If you cannot solve your problem	<ul style="list-style-type: none">• Visit our website: http://www.panasonic.com/support• Contact us via the web at: http://www.panasonic.com/contactinfo• Call our customer call center at: 1-800-211-PANA(7262)

openLCR Service for Caller IQ

Problem	Cause & Remedy
When you try to download the data from openLCR, the voice prompt is not announced from the handset while “Listen & follow phone guidance.” is being displayed.	<ul style="list-style-type: none">• Check the settings (p. 9–11).• Dialing to openLCR may have been disconnected. Try again (p. 80).• If you cannot solve a problem, consult openLCR(see below).
For more information about Caller IQ	<ul style="list-style-type: none">• Call openLCR’s customer service department at 1-866-openLCR(1-866-673-6527).• openLCR’s web site: www.openLCR.com

openLCR Service for Caller IQ

This unit is compatible with services provided by openLCR.

Important:

- If you have any questions regarding the openLCR service, call openLCR's customer service department at 1-866-openLCR(1-866-673-6527).
- NEITHER PANASONIC COMMUNICATIONS CO., LTD. (PCC) NOR MATSUSHITA ELECTRIC CORPORATION OF AMERICA (MECA) IS IN ANY WAY AFFILIATED WITH, OR RESPONSIBLE FOR THE ACTS OR OMISSIONS OF, OPENLCR.COM, INC. (OPENLCR). NEITHER PCC NOR MECA NOR ANY OF THEIR EMPLOYEES OR AFFILIATES OR CUSTOMERS MAKE ANY WARRANTIES OR REPRESENTATIONS, EITHER EXPRESS OR IMPLIED, TO ANY CUSTOMER OR ANY OTHER THIRD PARTY WITH RESPECT TO ANY OF THE SERVICES PROVIDED BY OPENLCR, NOR ASSUME NOR CREATE ANY OTHER OBLIGATION OF ANY KIND ON BEHALF OF OPENLCR.

Turning Caller IQ on or off **Handset**

After the first download to your phone, Caller IQ features are automatically turned on. If you wish, you can turn off Caller IQ.

- When Caller IQ is on, “[CIQ]” is displayed while talking.

To turn Caller IQ off (when it is already on)

1 Press **[MENU]**.

2 Scroll to “Caller IQ” by pressing **[▼]** or **[▲]**, then press **Select**.

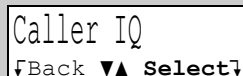

Caller IQ
↵Back ▼▲ Select↵

3 Scroll to “Turn CIQ off?” by pressing **[▼]** or **[▲]**, then press **Yes**.

- “Caller IQ off” is displayed.

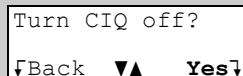

Turn CIQ off?
↵Back ▼▲ Yes↵

4 Press **[OFF]**.

To turn Caller IQ on (after it was turned off)

1 Follow steps 1 to 2 of “To turn Caller IQ off” above.

2 Press **Yes** at “Turn CIQ on?”.

- “Caller IQ on” is displayed.

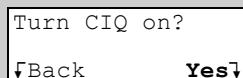

Turn CIQ on?
↵Back Yes↵

3 Press **[OFF]**.

- If you turn Caller IQ on or off using one of the handsets, you will not need to turn on/off using another handset.

Downloading Data

You can download the following data to your unit from the openLCR web site.

- Phone book data
- Ringer melodies (Custom ringtone)
- Function setup for your unit
- Information such as weather forecasts, stock quotes, lottery results, sports scores and horoscopes (Internet content)

Accessing the openLCR web site can be done from any computer with Internet access.

- While downloading from openLCR, “*dl*” flashes on the base unit display.

To create data on the openLCR web site

1 Access the openLCR’s web site at www.openLCR.com and click on the “Manage Account/Login” tab.

2 Enter your Telephone Number and Password, then click .

3 Follow the on-screen instructions.

Phone book data:

- To create the phone book data, enter a name of up to 16 characters, and a phone number of up to 32 digits.
- If you have already stored items into the phone book of the unit, you need to enter all of those stored items again using the openLCR web site. Then, add all new items through the openLCR web site.

Ringer melodies:

- The unit stores up to 2 ringer melodies in the handsets and base unit separately and you can select up to 2 ringer melodies as ringer tone (p. 69, 70, 81).

Function setup:

- See openLCR’s web site for function items available for download.

Information:

- You can select the information which you want to show on the handset display.

-
- If you have stored items in the phone book of the unit, you also need to store those items on the web site.
 - The description on the openLCR web screen is subject to change without notice.

openLCR Service for Caller IQ

To download data from openLCR **Handset**

Each time you download data (p. 79) from openLCR, the information stored in your unit will be updated. To view up-to-date information, you will need to download it to your unit.

- You can select the items of information on the web site which you want to view.
- Each handset can download its own data only. Either handset can be used to download data for base unit.
- Horoscopes are for entertainment purposes only.

1 Press **[MENU]**.

2 Scroll to “Caller IQ” by pressing **[▼]** or **[▲]**, then press **Select**.

3 Scroll to “Get new Info.?” by pressing **[▼]** or **[▲]**, then press **Yes**.

- The unit will dial openLCR automatically.
- A voice prompt will be heard.

If you live in or move from another area to Fort Collins, Colorado, press **[#]** before pressing **Yes**.

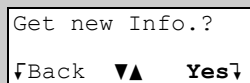

Get new Info.?
Back ▲▲ Yes

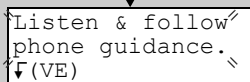

Listen & follow
phone guidance.
↓ (VE)

4 Follow the voice prompt to start downloading.

- If you have rotary or pulse service, you need to press **[*]** to change the dialing mode temporarily to tone, before following the voice prompt.
- When downloading starts, the display will show the message on the right.
- After downloading starts, the handset must be off hook. **DO NOT PLACE** the handset on the base unit or charger (placing the handset on the base unit or charger will terminate the download process). **DO NOT PRESS [OFF]** (pressing **[OFF]** will terminate the download process).

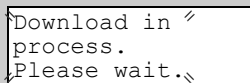

Download in
process.
Please wait.

5 When downloading is complete, a beep sounds.

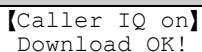

[Caller IQ on]
Download OK!

- You can also go to the Caller IQ menu after pressing **[↶]** or **[↷]**. Press **[MENU]**, then **[2]** to select “2=Caller IQ”. Follow steps 3 to 5 above.
- If the handset beeps 3 times and “Download incomplete. Try again.” is displayed, the unit has lost communication with openLCR. Store items by following the steps below.
 1. Access the openLCR web site.
 2. Go to the web screen to create the data.
 - To download the phone book data, check the “Re-Download All” box, then click **Save**. Then go to step 3.
 3. Start again from step 1 (“To download data from openLCR”).

openLCR Service for Caller IQ

- If the handset beeps 3 times and “Download incomplete. Phone book full.” is displayed, some items could not be stored in the phone book. Store items by following the steps below.
 1. Erase items which do not exist on the web from the phone book of the unit (p. 42).
 2. Access the openLCR web site.
 3. Go to the web screen to create the phone book data.
 4. Check the “Re-Download All” box, then click **Save**.
 5. Start again from step 1 (“To download data from openLCR” on page 80).
- You cannot access the openLCR server if a telephone or fax machine on the same phone line is in use.
- While the unit is downloading data from openLCR, the Call Waiting Service cannot be used.

To use downloaded melodies as the ringer tone

The melody(ies) you download from openLCR are stored in the base unit and handsets and will be heard when you receive an outside call. The names of each melody (up to 14 characters) are also downloaded.

To select the desired melody, go to the Ringer tone menu in the Ringer setting menu (p. 18, 19). Downloaded melody 1 and 2 can be selected by:

- If using the handset, press **[▼]**, **[▲]**, **[8]** or **[9]**.
- If using the base unit, press **[8]** or **[9]**.

To view information

1 Press **[MENU]**.

2 Scroll to “Caller IQ” by pressing **[▼]** or **[▲]**, then press **Select**.

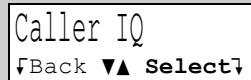

Caller IQ
fBack ▼▲ Selectf

3 Press **Yes** at “View Info.?”.

- The items of information which you selected on the web are displayed.
- If information is not downloaded to your unit, “Get new Info.?” will be displayed. To download information, see page 80.

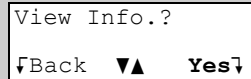

View Info.?
fBack ▼▲ Yesf

4 Scroll to the desired information by pressing **[▼]** or **[▲]**.

- You can also select the desired information by pressing dialing buttons.

5 When finished, press **[OFF]** or place the handset on the base unit or charger.

Important Safety Instructions

When using this unit, basic safety precautions should always be followed to reduce the risk of fire, electric shock, or personal injury.

1. Read and understand all instructions.
2. Follow all warnings and instructions marked on this unit.
3. Unplug this unit from AC outlets before cleaning. Do not use liquid or aerosol cleaners. Use a damp cloth for cleaning.
4. Do not use this unit near water, for example, near a bathtub, washbowl, kitchen sink, or the like.
5. Place this unit securely on a stable surface. Serious damage and/or injury may result if the unit falls.
6. Do not cover slots and openings on the unit. They are provided for ventilation and protection against overheating. Never place the unit near radiators, or in a place where proper ventilation is not provided.
7. Use only the power source marked on the unit. If you are not sure of the type of power supplied to your home, consult your dealer or local power company.
8. Do not place objects on the power cord. Install the unit where no one can step or trip on the cord.
9. Do not overload wall outlets and extension cords. This can result in the risk of fire or electric shock.
10. Never push any objects through slots in this unit. This may result in the risk of fire or electric shock. Never spill any liquid on the unit.
11. To reduce the risk of electric shock, do not disassemble this unit. Take the unit to an authorized servicer when service is required. Opening or removing covers may expose you to dangerous voltages or other risks. Incorrect reassembly can cause electric shock when the unit is subsequently used.
12. Unplug this unit from the wall outlet and refer servicing to an authorized servicer when the following conditions occur:
 - A. When the power supply cord or plug is damaged or frayed.
 - B. If liquid has been spilled into the unit.
 - C. If the unit has been exposed to rain or water.
 - D. If the unit does not work normally by following the operating instructions. Adjust only controls covered by the operating instructions. Improper adjustment may require extensive work by an authorized servicer.
 - E. If the unit has been dropped or physically damaged.
 - F. If the unit exhibits a distinct change in performance.
13. During thunderstorms, avoid using telephones except cordless types. There may be a remote risk of an electric shock from lightning.
14. Do not use this unit to report a gas leak, when in the vicinity of the leak.

SAVE THESE INSTRUCTIONS

Important Safety Instructions

CAUTION:

To reduce the risk of fire or injury to persons, read and follow these instructions.

1. Use only the battery(ies) specified.
2. Do not dispose of the battery(ies) in a fire. They may explode. Check with local waste management codes for special disposal instructions.
3. Do not open or mutilate the battery(ies). Released electrolyte is corrosive and may cause burns or injury to the eyes or skin. The electrolyte may be toxic if swallowed.
4. Exercise care in handling batteries in order not to short the battery to conductive materials such as rings, bracelets, and keys. The battery and/or conductor may overheat and cause burns.
5. Charge the battery(ies) provided with or identified for use with this product only in accordance with the instructions and limitations specified in this manual.

WARNING:

TO PREVENT FIRE OR SHOCK HAZARD, DO NOT EXPOSE THIS PRODUCT TO RAIN OR ANY TYPE OF MOISTURE.

- The AC adaptor is used as the main disconnect device, ensure that the AC outlet is located/installed near the unit and is easily accessible.

FCC and Other Information

This equipment complies with Part 68 of the FCC rules and the requirements adopted by the ACTA. On the bottom of this equipment is a label that contains, among other information, a product identifier in the format US:ACJ-----. If requested, this number must be provided to the telephone company.

Registration No. (found on the bottom of the unit)
Ringer Equivalence No. (REN) 0.1B

A plug and jack used to connect this equipment to the premises wiring and telephone network must comply with the applicable FCC Part 68 rules and requirements adopted by the ACTA. A compliant telephone cord and modular plug is provided with this product. It is designed to be connected to a compatible modular jack that is also compliant.

The REN is used to determine the number of devices that may be connected to a telephone line. Excessive RENs on a telephone line may result in the devices not ringing in response to an incoming call. In most but not all areas, the sum of RENs should not exceed five (5.0). To be certain of the number of devices that may be connected to a line, as determined by the total RENs, contact the local telephone company. For products approved after July 23, 2001, the REN for this product is part of the product identifier that has the format US:AAAEQ##TXXXX. The digits represented by ## are the REN without a decimal point (e.g., 03 is a REN of 0.3). If this equipment causes harm to the telephone network, the telephone company will notify you in advance that temporary discontinuance of service may be required. But if advance notice isn't practical, the telephone company will notify the customer as soon as possible. Also, you will be advised of your right to file a complaint with the FCC if you believe it is necessary.

The telephone company may make changes in its facilities, equipment, operations or procedures that could affect the operation of the equipment. If this happens the telephone company will provide advance notice in order for you to make necessary modifications to maintain uninterrupted service.

If trouble is experienced with this equipment, for repair or warranty information, please contact a Factory Servicenter or other Authorized Servicer. If the equipment is causing harm to the telephone network, the telephone company may request that you disconnect the equipment until the problem is resolved.

Connection to party line service is subject to state tariffs. Contact the state public utility commission, public service commission or corporation commission for information.

If your home has specially wired alarm equipment connected to the telephone line, ensure the installation of this equipment does not disable your alarm equipment. If you have questions about what will disable alarm equipment, consult your telephone company or a qualified installer.

WHEN PROGRAMMING EMERGENCY NUMBERS AND(OR) MAKING TEST CALLS TO EMERGENCY NUMBERS:

- 1) Remain on the line and briefly explain to the dispatcher the reason for the call.
- 2) Perform such activities in the off-peak hours, such as early morning or late evenings.

This device complies with Part 15 of the FCC Rules. Operation is subject to the following two conditions: (1) This device may not cause harmful interference, and (2) this device must accept any interference received, including interference that may cause undesired operation.

FCC and Other Information

Privacy of communications may not be ensured when using this phone.

CAUTION:

Any changes or modifications not expressly approved by the party responsible for compliance could void the user's authority to operate this device.

Note:

This equipment has been tested and found to comply with the limits for a Class B digital device, pursuant to Part 15 of the FCC Rules. These limits are designed to provide reasonable protection against harmful interference in a residential installation. This equipment generates, uses, and can radiate radio frequency energy and, if not installed and used in accordance with the instructions, may cause harmful interference to radio communications. However, there is no guarantee that interference will not occur in a particular installation. If this equipment does cause harmful interference to radio or television reception, which can be determined by turning the equipment off and on, the user is encouraged to try to correct the interference by one or more of the following measures:

- Reorient or relocate the receiving antenna.
- Increase the separation between the equipment and receiver.
- Connect the equipment into an outlet on a circuit different from that to which the receiver is connected.
- Consult the dealer or an experienced radio/TV technician for help.

Some cordless telephones operate at frequencies that may cause interference to nearby TVs and VCRs. To minimize or prevent such interference, the base of the cordless telephone should not be placed near or on top of a TV or VCR. If interference is experienced, move the cordless telephone further away from the TV or VCR. This will often reduce, or eliminate, interference.

Operating near 2.4GHz electrical appliances may cause interference. Move away from the electrical appliances.

FCC RF Exposure Warning:

This product complies with FCC radiation exposure limits set forth for an uncontrolled environment.

To comply with FCC RF exposure requirements the base unit must be installed and operated with its antenna located 20 cm or more between antenna and all person's body (excluding extremities of hands, wrist and feet). The handset unit may be carried and operated with only the specific provided belt-clip. Other non-tested belt-clips or similar body-worn accessories may not comply and must be avoided. The base and handset units must not be co-located or operated in conjunction with any other antenna or transmitter.

This equipment is hearing aid compatible as defined by the FCC in 47 CFR Section 68.316.

When you hold the phone to your ear, noise might be heard in your Hearing Aid. Some Hearing Aids are not adequately shielded from external RF (radio frequency) energy. If noise occurs, use an optional headset accessory or the speakerphone option (if applicable) when using this phone. Consult your audiologist or Hearing Aid manufacturer about the availability of Hearing Aids which provide adequate shielding to RF energy commonly emitted by digital devices.

FCC and Other Information

A TIA/EIA-IS-968 compliant telephone cord and modular plug is provided with this equipment. This equipment is designed to be connected to the telephone network or premises wiring using a compatible modular jack that is also TIA/EIA-IS-968 compliant.

The software contained in this equipment to allow user access to the network must be ungraded to recognize newly established network area codes and exchange codes as they are placed into service.

Failure to upgrade the premises systems or peripheral equipment to recognize the new codes as they are established will restrict the customer and the customer's employees from gaining access to the network and to these codes.

- **Environment** — do not place the unit in a room where the temperature is less than 5°C (41°F) or greater than 40°C (104°F). Allow 10 cm (4") clearance around the unit for proper ventilation. Avoid excessive smoke, dust, mechanical vibration, shock, or direct sunlight.
- **Medical** — consult the manufacturer of any personal medical devices, such as pacemakers or hearing aids, to determine if they are adequately shielded from external RF (radio frequency) energy. (The unit operates in the frequency range of 2400MHz to 2481MHz, and the power output level can range 0.04 to 0.1 watts.) Do not use the unit in health care facilities if any regulations posted in the area instruct you not to do so. Hospitals or health care facilities may be using equipment that could be sensitive to external RF (radio frequency) energy.
- **Routine care** — wipe the unit with a soft cloth. Do not use benzine, thinner, or any abrasive powder. When you leave the unit unused for a long period of time, unplug the AC adaptor from the outlet.
- **If there is any trouble** — disconnect the unit from the telephone line and connect a known working phone. If the known working phone operates properly, have your unit repaired by one of the authorized Panasonic Factory Service Centers. If the known working phone does not operate properly, consult your telephone company.

Index

A

- Accessories 2
- Answering calls, base unit 29
- Answering calls, handset 29
- Answering System 55
- Auto talk 16, 29

B

- Backlit LCD 27
- Base unit location 3
- Battery charge 3, 10
- Battery information* 11
- Battery replacement 11
- Battery strength 10
- Belt clip 66

C

- Call monitoring* 56
- Call share 50
- Call Waiting Caller ID display 51
- Call waiting tone 51
- Caller ID number auto edit* 35
- Caller ID service 14, 30
- Caller IQ 78
- Caller List, editing 34
- Caller List, erasing 37
- Caller List, storing 36
- Caller List, viewing 33
- Calling back from the Caller List 33
- Chain dial* 41
- Conf (Conference) 50
- Conference calls 50
- Copy phone book* 43, 44

D

- Date and time* 14
- Dialing mode 15
- Direct commands 69, 70
- Display language 15

E

- Erasing a message 60, 65
- Erasing all messages 60, 65
- Error messages 71
- Extension number 45

F

- FCC and other information 84
- FLASH button 52
- Flash time 52
- Function menu,*
 - Direct commands* 69
 - Function menu, selection 12
 - Function menu, table 13

G

- Greeting message* 20

H

- Headset, optional 66
- Hold 26, 28

I

- Incoming call tone 53
- Installation, AC adaptor 9
- Installation, battery 10
- Installation, charger unit 9
- Installation, telephone line cord 9
- Intercom call 45
- Intercom, paging 45

K

- Key tone 54

L

- LCD contrast 20
- Lighted handset keypad 27
- Line mode 16
- Listening to messages 57, 58, 62
- Location of controls 6, 7

M

- Making calls, base unit 28
- Making calls, handset 25, 26
- Memo message 61
- Message alert* 24
- Message storage 22
- Microphone, base unit 21, 28
- Microphone, handset 25
- Monitoring incoming calls* 56
- Mute 51

Index

N

- Navigator key 8
- Noise 3
- Number of rings 23

O

- openLCR 78

P

- Pause 52
- Phone book* 38
- Phone book, copying* 43, 44
- Phone book, dialing 40
- Phone book, downloading 79
- Phone book, editing 42
- Phone book, erasing 42
- Phone book, names 39
- Phone book, storing 38
- Power failure 9, 14, 22
- Pulse service 51

R

- Recording mode* 24
- Recording time 22
- Redial 26, 28
- Redial list 26
- Registration* 54
- Remote code 63
- Remote operation, handset 58
- Remote operation,
touch tone phone 62
- Ringer off 17, 18, 29
- Ringer tone 18, 19
- Ringer volume 17, 18
- Rotary service, tone dialing 51

S

- Safety instructions 82
- Shipping product
for service Back Cover
- Soft keys 8
- Specifications 91
- SP-phone, base unit 28
- SP-phone, handset 25

T

- Talking Caller ID* 31
- Toll saver 23
- Transferring a call* 48
- Troubleshooting,
Answering System 75
- Troubleshooting, general 76
- Troubleshooting,
openLCR Service for Caller IQ . . 77
- Troubleshooting,
Telephone System 73
- TTY 2, 90, Back Cover

V

- VE (Voice Enhancer) 27
- Voice enhancer technology* 27
- Voice menu 58, 64
- Voice paging* 47
- Volume control, base unit 28, 59
- Volume control, handset 26, 59

W

- Wall mounting 67
- Warranty 89

• “—” indicates important information and frequently used features.

PANASONIC CONSUMER
ELECTRONICS COMPANY, DIVISION
OF MATSUSHITA ELECTRIC
CORPORATION OF AMERICA
One Panasonic Way
Secaucus, New Jersey 07094

PANASONIC SALES COMPANY,
DIVISION OF MATSUSHITA
ELECTRIC OF PUERTO RICO, INC.,
Ave. 65 de Infanteria, Km. 9.5
San Gabriel Industrial Park
Carolina, Puerto Rico 00985

Panasonic Telephone Products Limited Warranty

Limited Warranty Coverage

If your product does not work properly because of a defect in materials or workmanship, Panasonic Consumer Electronics Company or Panasonic Sales Company (collectively referred to as "the warrantor") will, for the length of the period indicated on the chart below, which starts with the date of original purchase ("Limited Warranty period"), at its option either (a) repair your product with new or refurbished parts, or (b) replace it with a new or a refurbished product. The decision to repair or replace will be made by the warrantor.

Parts	Labor
One (1) Year	One (1) Year

During the "Labor" Limited Warranty period there will be no charge for labor. During the "Parts" Limited Warranty period, there will be no charge for parts. You must mail-in your product during the Limited Warranty period. This Limited Warranty excludes both parts and labor for batteries, antennas, and cosmetic parts (cabinet). This Limited Warranty only applies to products purchased and serviced in the United States or Puerto Rico. This Limited Warranty is extended only to the original purchaser and only covers products purchased as new.

Mail-In Service

For assistance in the continental U.S.A. in obtaining repairs please ship the product to:

**Panasonic Services Company Customer Servicenter
Suite B 4900 George McVay Drive McAllen, TX 78503**

For assistance in Puerto Rico call Panasonic Sales Company (787)-750-4300 or fax (787)-768-2910.

For Limited Warranty service for headsets if a headset is included with this product please call Panasonic Call Center at 1-800-211-PANA (7262).

When shipping the unit carefully pack, include all accessories, and send it prepaid, adequately insured and preferably in the original carton. Include a letter detailing the complaint and provide a day time phone number where you can be reached.

IF REPAIR IS NEEDED DURING THE LIMITED WARRANTY PERIOD THE PURCHASER WILL BE REQUIRED TO FURNISH A SALES RECEIPT/PROOF OF PURCHASE INDICATING DATE OF PURCHASE, AMOUNT PAID AND PLACE OF PURCHASE. CUSTOMER WILL BE CHARGED FOR THE REPAIR OF ANY UNIT RECEIVED WITHOUT SUCH PROOF OF PURCHASE.

Limited Warranty Limits And Exclusions

This Limited Warranty ONLY COVERS failures due to defects in materials or workmanship, and DOES NOT COVER normal wear and tear or cosmetic damage. The Limited Warranty ALSO DOES NOT COVER damages which occurred in shipment, or failures which are caused by products not supplied by the warrantor, or failures which result from accidents, misuse, abuse, neglect, mishandling, misapplication, alteration, faulty installation, set-up adjustments, misadjustment of consumer controls, improper maintenance, power line surge, lightning damage, modification, introduction of sand, humidity or liquids, commercial use such as hotel, office, restaurant, or other business or rental use of the product, or service by anyone other than a Factory Servicenter or other Authorized Servicer, or damage that is attributable to acts of God.

THERE ARE NO EXPRESS WARRANTIES EXCEPT AS LISTED UNDER "LIMITED WARRANTY COVERAGE". THE WARRANTOR IS NOT LIABLE FOR INCIDENTAL OR CONSEQUENTIAL DAMAGES RESULTING FROM THE USE OF THIS PRODUCT, OR ARISING OUT OF ANY BREACH OF THIS LIMITED WARRANTY. (As examples, this excludes damages for lost time, lost calls or messages, cost of having someone remove or re-install an installed unit if applicable, travel to and from the servicer. The items listed are not exclusive, but are for illustration only.) ALL EXPRESS AND IMPLIED WARRANTIES, INCLUDING THE WARRANTY OF MERCHANTABILITY, ARE LIMITED TO THE PERIOD OF THE LIMITED WARRANTY.

Some states do not allow the exclusion or limitation of incidental or consequential damages, or limitations on how long an implied warranty lasts, so the exclusions may not apply to you. This Limited Warranty gives you specific legal rights and you may also have other rights which vary from state to state. If a problem with this product develops during or after the Limited Warranty period, you may contact your dealer or Servicenter. If the problem is not handled to your satisfaction, then write to the warrantor's Consumer Affairs Department at the addresses listed for the warrantor.

PARTS AND SERVICE, WHICH ARE NOT COVERED BY THIS LIMITED WARRANTY, ARE YOUR RESPONSIBILITY.

Customer Services Directory

Obtain Product Information and Operating Assistance; locate your nearest Dealer or Servicenter; purchase Parts and Accessories; or make Customer Service and Literature requests by visiting our Web Site at:

<http://www.panasonic.com/support>

or, contact us via the web at:

<http://www.panasonic.com/contactinfo>

You may also contact us directly at: 1-800-211-PANA (7262),
Monday-Friday 9 am-9 pm; Saturday-Sunday 10 am-7 pm, EST.

For hearing or speech impaired TTY users, TTY : 1-877-833-8855

Accessory Purchases

Purchase Parts, Accessories and Instruction Books online for all Panasonic Products by visiting our Web Site at:

<http://www.pasc.panasonic.com>

or, send your request by E-mail to:

npcparts@panasonic.com

You may also contact us directly at:

1-800-332-5368 (Phone) 1-800-237-9080 (Fax Only)

(Monday - Friday 9 am to 8 pm, EST.)

Panasonic Services Company

20421 84th Avenue South, Kent, WA 98032

(We Accept Visa, MasterCard, Discover Card, American Express,
and Personal Checks)

For hearing or speech impaired TTY users, TTY : 1-866-605-1277

Service in Puerto Rico

***Matsushita Electric of Puerto Rico, Inc. Panasonic Sales Company
Factory Servicenter:***

***Ave. 65 de Infantería, Km. 9.5, San Gabriel Industrial Park,
Carolina, Puerto Rico 00985***

Phone (787)750-4300, Fax (787)768-2910

Specifications

■ Base Unit

- Power Supply:** AC Adaptor (120 V AC, 60 Hz)
- Power Consumption:** Standby: Approx. 2.0 W
Maximum: Approx. 5.4 W
- Frequency:** 2.4 GHz – 2.48 GHz
- Dimensions (H x W x D):** Approx. 85 mm x 175 mm x 200 mm
(3 11/32" x 6 7/8" x 7 7/8")
- Mass (Weight):** Approx. 470 g (1.04 lb.)

■ Charger

- Power Supply:** AC Adaptor (120 V AC, 60 Hz)
- Power Consumption:** Standby: Approx. 0.8 W
Maximum: Approx. 4.0 W
- Dimensions (H x W x D):** Approx. 69 mm x 74 mm x 99 mm
(2 23/32" x 2 29/32" x 3 29/32")
- Mass (Weight):** Approx. 110 g (0.24 lb.)

■ Handset

- Power Supply:** Ni-MH battery (3.6 V, 830 mAh)
- Frequency:** 2.4 GHz – 2.48 GHz
- Dimensions (H x W x D):** Approx. 208 mm x 52 mm x 39 mm
(8 3/16" x 2 1/16" x 1 17/32")
- Mass (Weight):** Approx. 190 g (0.42 lb.)
- Security Codes:** 1,000,000

■ Dialing Mode: Tone (DTMF)/Pulse

■ Operating Environment: 5 °C – 40 °C (41 °F – 104 °F)

Specifications are subject to change without notice.

For your future reference

Serial No. _____ Date of purchase _____

(found on the bottom of the unit)

Name and address of dealer _____

For product service

- Visit our website: <http://www.panasonic.com/support>
- Contact us via the web at: <http://www.panasonic.com/contactinfo>
- Call us at: 1-800-211-PANA(7262)

When you ship the product

- Carefully pack your unit, preferably in the original carton.
- Attach a letter, detailing the symptom, to the outside of the carton.

Symptom

- Send the unit to an authorized servicer, prepaid and adequately insured.
- Do not send your unit to the Panasonic Consumer Electronics Company listed below or to executive or regional sales offices. These locations do not repair consumer products.

- This cordless telephone is designed for use in the United States of America. Sale or use of this product in other countries may violate local laws.
- Ce téléphone sans fil est conçu pour être utilisé aux États-Unis d'Amérique. La vente ou l'emploi de cet appareil dans certains autres pays peut constituer une infraction à la législation locale.
- Este teléfono inalámbrico fue elaborado para uso en los Estados Unidos de América. La venta o el empleo de este producto en ciertos países puede constituir violación de la legislación local.
- このコードレス電話機は、日本国外での使用を目的として設計されており、日本国内での使用は法律違反となります。従って、当社では日本国内においては原則として修理などのサービスは致しかねます。

**If you need assistance with the setup or operation,
please call 1-800-211-PANA(7262)**

For hearing or speech impaired TTY users, TTY : 1-877-833-8855

**Panasonic Consumer Electronics Company,
Division of Matsushita Electric Corporation of America**
One Panasonic Way, Secaucus, New Jersey 07094

**Panasonic Sales Company,
Division of Matsushita Electric of Puerto Rico, Inc.**
Ave. 65 de Infantería, Km. 9.5, San Gabriel Industrial Park
Carolina, Puerto Rico 00985

© 2004 Panasonic Communications Co., Ltd. All Rights Reserved.

PQQX13991YA F1203-1024 ①